



# COUNTERTOP FABRICATION SOLUTIONS



# BROCHURE **SECTIONS**

- Introduction .....3
- Value Proposition..... 4-5
- Featured Brands.....6
- Seaming Adhesives ..... 7-9
- Seaming Accessories ..... 10
- Structural Adhesives..... 11-14
- Laminating and Honeycomb Epoxy..... 15
- Cel Components Honeycomb Panels ..... 16
- Deform-Nut® TC/SC ..... 17
- KEEP-NUT™ Sink & Panel Mount Inserts ..... 18
- KEEP-NUT™ Parts and Kits ..... 19
- KEEP-NUT™ Drilling Machine ..... 20
- Sink Clips and Glue-On Sink Anchors..... 21
- Glue-On Sink Anchor Kits ..... 22
- CounterBalance® Cabinetry Overhangs ..... 23
- CounterBalance® Flat Plate and Half-Wall Overhang Brackets ..... 24
- CounterBalance® Float Frame Brackets..... 25
- CounterBalance® Floating Countertop Brackets.....26-28
- CounterBalance® Shelving Brackets ..... 29
- CounterBalance® Surface, Stair & Cleat Brackets..... 30
- Sealers and Cleaners..... 31
- Boa Bond Advanced Hybrid Adhesive ..... 32
- Sealants..... 33
- Silicone - 100% RTV ..... 34
- Chem-Set™ Chip Repair Kits .....35-36
- Porcelain Scratch Repair Kit ..... 37
- Tape and Surface Protection Film ..... 38
- Hot Melt Adhesives ..... 39
- Dispensing Guns Industrial..... 40
- Abrasives and Pads ..... 41-42
- Laminate and Woodworking Adhesives.....43-44
- Xcelerate..... 45
- Get In Touch with the Team.....46-47

## FABRICATION INDUSTRY OVERVIEW: **WHEN VENDORS DON'T CUT IT**

In uncertain economic conditions filled with skilled labor shortages, supply chain issues, and rapidly changing market demands, countertop fabricators need more than a vendor. They need a partner – one that brings real solutions to fabrication challenges, offering valuable advice, and troubleshooting problems when they inevitably occur.

Strong partnerships are a must for all facets of the business, including your assembly operations. We can help improve processes and aesthetics, maintain supply continuity, reduce labor costs, and achieve your strategic objectives using our 100+ years of combined experience.

### Proud Members/Sponsors of these Organizations:





## WORK WITH CHEMICAL CONCEPTS **THE BONDING EXPERTS**

Chemical Concepts is a business-to-business provider of engineered solutions involving adhesives, sealants, tapes and specialty fasteners for the countertop fabrication industry.

With 60+ years of pioneering the use of adhesives, Chemical Concepts takes pride in providing custom-engineered solutions designed to meet your countertop fabrication needs. We consult with fabricators every day to overcome challenges in design, process and labor by providing high-performance products and expert support, delivered on time.

**We're more than just an adhesive and fastener supplier. We're a solutions provider.**



# CHEMICAL CONCEPTS MAKES **FABRICATION PROBLEMS DISAPPEAR**

We help fabricators of all kinds solve challenging problems. We're not industry generalists. We're the experts in solving challenging bonding problems.

**We can help you:**



### **Get The Right Adhesive**

Find the right adhesive for your application, and give you full confidence the solution will work.



### **Increase Output**

Improve processes, decrease project times and cut labor costs.



### **Solve Challenging Problems**

Get expert support you need on adhesives that you cannot find with generalist distributors.



### **Improve Job Quality**

Upgrade the aesthetics of your finished projects by creating invisible, color-matched seams and beautiful floating countertops with less time and effort.



### **Increase Efficiency**

Improve efficiency and reduce labor costs for sink mounting, seaming, miters, rodding, vertical mounting, honeycomb lamination, support, and sealing/surface protection and repairs.



### **Ensure Consistent Supply**

Consolidate supply for countertop fabrication accessory products including adhesives, tapes, brackets, hot melts, mechanical fasteners, chip repair and more.



### **Decrease Call Backs**

Reduce headaches surrounding bleeding, stains, poor color matches, wasted time and call backs.

## FEATURED **BRANDS**

Chemical Concepts maintains relationships with many of the leading brands in the industry. Those relationships mean the highest quality products, unmatched technical support, and access to a huge portfolio of innovative technology to match with our customers' needs.

**Specialinsert**

**Integra Adhesives**

**BONSTONE**  
• MATERIALS CORPORATION •  
— Since 1962 —

**STAIN•PROOF**  
CARE + MAINTENANCE SOLUTIONS

**Chem-Set**™

**CounterBalance**®

**Tensorgrip**®

**CEL COMPONENTS**

**inkits**  
MOUNTING SOLUTIONS

**SUREBONDER**®

**STA'-PUT**

# Seaming Adhesives

Better Color Matches vs Epoxy

CREATE A PERFECT SEAM EVERY TIME!

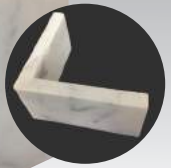

## Integra Adhesives



### SURFACE BONDER RAPID



Surface Bonder Rapid adhesive is developed especially to improve production output for high volume fabrication. The high strength, no sag formula is available in a range of colors to match the most popular surface designs.

- 2X faster set up time compared to the standard formula
- Sandable in 15-18 min @ 70°F
- Perfect seaming adhesive for colder climates/seasons
- Save time on installs and fabrication
- Designed for Natural Stone, Quartz, Compact Ceramics, and Porcelain surfaces



#### GUN



INTDI250MAN  
250ML Manual  
10:1 Gun

#### Mixing Tip

INTTIPSXSTREAM



### SURFACE BONDER ZERO



Surface Bonder Zero is a non sagging adhesive specifically designed for Quartz, Compact Sintered Materials and Natural Stone products. Its non-sag properties make it ideal for mitered edges, the adhesive stays right where you put it.

- Revolutionary seaming adhesive Designed for granite, marble, porcelain, sintered stone, glass, engineered stone, and natural stone products
- Drip-less 'Non-Sag' Acrylic Adhesive
- Designed for vertical applications, mitered edges and deck seams

250 ml



#### GUN



INTDI250MAN  
250ML Manual  
10:1 Gun

#### Mixing Tip

INTTIPSXSTREAM



### SURFACE BONDER XI



Surface Bonder XI is the latest generation of color matched adhesives for the surfacing industry. Developed for modern demanding fabrication methods such as laminating, mitring, v-grooving, integral mounted sinks and bowls, and applications subject to dynamic loads.

- Seaming Adhesive for Quartz Natural Stone, Solid Surface, Ceramic and more
- Eliminate Hand Mixing and Tinting

250 ml



#### GUN



INTDI250MAN  
250ML Manual  
10:1 Gun

#### Mixing Tip

INTTIPSXSTREAM



### SURFACE BONDER ULTRA



Surface Bonder Ultra is a premium, UV stable, Modified Hybrid Polyaspartic surfacing adhesive for indoor and outdoor applications. This unique adhesive will not yellow, stain, or bleed making it perfect for white marbles.

- Laminating / Seaming / V-Groove systems Automates Adhesive Application
- Provides the Strength of Epoxy, the Speed and Color stability of Acrylic
- Reduce Waste, Eliminate Hand Mixing and Tinting
- Polish to match the gloss of surrounding material



#### GUN

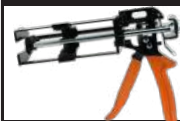

INTDI200MAN  
200ML Manual  
2:1 Gun

#### Mixing Tip

INTTIPSULTRA



# COMPLETE COLOR MATCHING SYSTEM, BETTER MATCHES FASTER AND EASIER

## UNIQUE FEATURES



- Simplified color matching system
- Smartphone app with easy color formulas to match popular natural & engineered stones
- 32 premixed color pigments in measured dosing pump cans
- Faster ramp-up time for new hires
- More forgiving ratios for improved quality control
- Indoor/Outdoor with high UV performance/ Non-yellowing
- Fast set times without over-catalyzed, brittle glue
- Eliminate redundant adhesives in the shop
- Suitable for natural stone, quartz, & porcelain
- Innovative eco-friendly foil pouches for mess-free dispensing



# Stone Seam™

Knife Grade adhesive with a game-changing color matching system.



## Available in your choice of Resin

Stone Seam Pro 1000 Clear Flowing Adhesive

Stone Seam Pro 1500 Clear Knife Grade Adhesive

Stone Seam Pro 1800 Chameleon Knife Grade Adhesive

## COLOR REFERENCE CHART

### STONE SEAM COLORING PASTE



## SEE THE DIFFERENCE

Better UV resistance, exterior performance and less yellowing than leading brand!

Leading Knife Grade

Chem-Set™ Stone Seam





# Seaming Adhesives

## Chem-Set™ Stone Seam™



### Stone Seam PRO 1500 Clear Knife Grade

Stone Seam Clear Knife Grade is the ultimate professional-grade non-yellowing UV-Stable indoor/outdoor bulk seaming adhesive.

- Knife grade formulation - no dripping on cabinets, floor, or tools
- Fast working times
- Fast fixture time
- Simple, reliable, and repeatable color system
- High UV stability - rated for indoor and outdoor applications
- Forgiving Formula

SKU: CCA-SSPRKGCY



### Stone Seam PRO 1800 Chameleon Knife Grade Adhesive

Stone Seam Chameleon (Transparent-White) Knife Grade is the ultimate professional-grade non-yellowing UV-Stable indoor/outdoor bulk seaming adhesive. Perfect for White quartz, granite, marble, porcelain, and ceramics the Chameleon (Transparent-White) color offers a great base to start before adding in your different coloring pastes.

- Knife grade formulation - no dripping on cabinets, floor, or tools
- Fast working times
- Fast fixture time
- Strong bonds to quartz, granite, marble, porcelain, and ceramics
- Forgiving Formula

SKU: CCA-SSPRKGCH



### Stone Seam PRO 1000 Clear Flowing Adhesive

Stone Seam Pro Clear Flowing is a two-part methacrylate, clear acrylic flowable seaming adhesive designed for the inconspicuous bonding of various substrates, including hard surface products such as granite, engineered stone, quartz, marble, cultured marble, glass, sintered stone, porcelain, and various ceramic surfaces with generally no preparation effort.

- Flowable Formulation - Great for filling cracks, seams, or topping off
- Fast working times
- Fast fixture time
- Strong bonds to quartz, granite, marble, porcelain, and ceramics
- Extremely clear, low viscosity top coat
- Forgiving Formula
- High UV stability - rated for indoor and outdoor application



SKU: CCA-SSPRFLCY



### Stone Seam C-30 Dripless

Two-part methacrylate, super flexible, dripless/non-sag, low shrink, low exotherm, ultra violet light stable, non-yellowing hard surfacing adhesive designed for the nearly seamless bonding of Porcelain, Sintered Stone, Glass, Engineered Stone, Marble, Quartz, and Natural Stone products.

- Non Drip / No Sag
- Auto-dispense system
- Invisible seams with 300+ pre-mixed colors
- Pre-mixed in 15 natural stone colors
- High strength
- UV resistant
- Trimmable
- LOW VOC

SKU: CCA-C30-XC



### Stone Seam C-20

Chem-Set C20 is a two-part methacrylate, non-yellowing, hard surfacing, high strength seaming / surfacing adhesive; the latest generation of color-matched adhesives for the surfacing industry.

- Auto-dispense system
- Eliminates hand-mixing
- Invisible seams with 300+ pre-mixed colors
- High strength
- UV stable
- Working time 12: minutes
- Fixture time 25: minutes

SKU: CCA C20 XC 250



# Seaming Accessories

## Chem-Set™ COLOR MASTER CM200



The Chem-Set Color Master CM200 allows you to accurately pinpoint the exact color of your stone surface. It then provides guidance on recreating the color seamlessly, ensuring a flawless match on your next project!

**Included in Each Kit:**

- Bluetooth Color Master scanner
- 1 activation code for Variable App
- 2 Seaming adhesive chip sets
- 1 Hard Case for Storage

**How Color Master Works:**

- Download the Variable App
- Apply the Chemical Concepts Stone Seam Activation Code (included with kit)
- Connect your Color Master Bluetooth device to the App
- Scan your stone



**How to Use the Chem-Set Color Master Bluetooth Stone Scanner**

with **VARIABLE**

**SKU: CCH-CM200-KIT**

## Chem-Set™ STONE SEAM Tape



Stone Seam Tape is part of an innovative finishing system for deck seams. Installers often spend a lot of time and energy removing excess adhesive from their joints with a razor blade, going back and forth over the length of the seam over and over, shaving a little bit of glue with each pass.

- Two sided tape for your desired Finish
- Glossy Side
- Matte Side
- Allow seaming adhesive to cure and remove after adhesive has skinned over

**SKU: CCA-SS005-SEAMTAPE**

## MITREFORMA MITRE CLAMP

A fabrication tool designed specifically for creating mitre fascias in a quick, precise and foolproof way. The "Mitre Forma" clamp is a key component that combined with using Seaming Adhesives it is the right tool to assemble 90° mitre edges in a fraction of the time.



- Cuts preparation time by 75%
- Simple to use
- Built-in square
- Creates high quality 90° seams
- Fascia clamping rod
- Disposable glue-catcher
- High-quality aluminum & stainless steel construction
- White rubber plate
- Quick release mechanism



**MitreForma Small:**  
for up to 130mm (5.12") fascias

**SKU: CCH-MITREFORMA-SM**



**MitreForma Large:**  
for 120 - 320mm (4.72" - 12.60") fascias

**SKU: CCH-MITREFORMA-LG**

# Structural Adhesives

## Integra Adhesives

### COMPONENT BONDER



Component Bonder is a two-part methacrylate, structural rodding and clip bonding adhesive designed for the structural bonding of sink clips, steel and fiberglass rodding materials, and steel and aluminum to solid surface (acrylic and polyester), engineered stone, quartz surfaces, and natural stone products. Combined at a ratio of 1:1, Component Bonder has a working time of 4 to 8 minutes and achieves nearly 90 percent of its ultimate strength in 10 to 15 minutes at room temperature curing.

- Two-part methacrylate, structural rodding, and clip bonding adhesive
- 400ml 1:1 adhesive cartridge that fit in standard 1:1 and 2:1 dispensers.
- Working time of 4 to 8 minutes
- Achieves nearly 90 percent of its ultimate strength in 10 to 15 minutes at room temperature curing

### component BONDER

#### GUN



Integra 400ML 1:1 Gun

#### Mixing Tip

INTTIPSBLUE



SKU: INTCB400NOCLR

### RODDING BONDER



Rodding Bonder RD50 is an epoxy based Bonder packaged in a 500ml dual component cartridge designed to embed fiberglass or steel reinforcement rods in countertops. Testing shows that the process can improve load tolerance up to 300% and deflection up to 1600%.

- Rodding Natural Stone
- Much higher strength than Polyester
- Less waste and more accurate mixing versus bulk
- Effective rodding on wet/damp stone



### RODDING BONDER

Stone Rodding Adhesive

#### GUN



INTDI500MAN Dual Variable 10:1 Gun

#### Mixing Tip

INTTIPXSXSTREAM



SKU: INTRO500NOCLR

### SUBSTRATE BONDER



Substrate Bonder SB100 is designed to develop strong, highly flexible bonds between Solid Surfaces, Engineered Stone, Granite and the materials such as MDF, Plywood, PVC, HPL, and ABS. Substrate Bonder SB100 greatly reduces assembly time, curing in as little as 15 minutes. Substrate Bonder SB100 is packaged in a 1:1 ratio 200ml cartridge and can be used in many applications that would normally require silicone

- Attach Quartz, Natural Stone and Solid Surface to wood or composite support structures
- SB100 greatly reduces assembly time, curing in as little as 15 minutes
- High strength and flexibility (elongation >100%)



### substrate BONDER

#### GUN



INTDI200MOG Dual Variable 1:1 Gun

#### Mixing Tip

INTTIPSBLUE



SKU: INTSU200NOCLR



# Structural Adhesives

## Chem-Set™ Rodmaster Structural Acrylic Rodding Compound



- Apply while stone is damp
- Low-Shrinkage Rodding Material which lessens the chances of breaks on marbles and quartzites



### Chem-Set™ 6600X ACRYLIC

- Two part methacrylate which has a faster time
- No need to wait for the stone to dry: No more blow torching or long waiting times
- 5-10x the strength compared to polyesters
- Easy to use Cartridge. Improves stones load capacity

SKU: CCA6600X-400F

	Work Time	Color
Size	3-6 min	Natural
	400ml	600ml
Guns		
	VR400XSP Dual Component Gun	535XSP Thrust Caulk Gun
Mixer	MFO-08-24T	MCQ-08-24T
Cure	15 MINUTES	



### Chem-Set™ 6600T ACRYLIC

- Quick Working Time: Working time of 4 minutes and reaches handling strength in 10 minutes
- No need to wait for the stone to dry: No more blow torching or long waiting times
- 5-10x the strength compared to polyesters
- Easy to use Cartridge. Improves stones load capacity

SKU: CCA6600T-500



	Work Time	Color
Size	3-6 min	Natural
	500ml	
Guns		
	B26T400X10 Dual Component Gun	
Mixer	MFOX-08-24T MIX RATIO: 10:1	
Cure	15 MINUTES	



### Chem-Set™ 633LV EPOXY

- Epoxy Based Adhesive for natural stone and quartz
- Cures within 15-20 minutes. Low Cost, Meter Mix
- Eliminate Hand Mixing
- Reduce Labor and Waste to Produces a low Cost system for reinforcing stone
- Adheres to steel and fiberglass reinforcing rods

SKU: CCA633LV-600

	Work Time	Color
Size	5-7 min.	Clear
	250ml	600ml
Guns		
	250 High Thrust Caulk Gun	535XSP Thrust Caulk Gun
Mixer	MGO-08-20T	160-AN824
Cure	15 MINUTES AT ROOM TEMPERATURE	

## Carbon Fiberglass Rodding

For use on granite, marble and engineered stones to add strength and reduce cracking. Made of the highest concentration of fiberglass strands.

- No Rust
- Bonds to Adhesives

SKU: WHA-133229

**Roll size:**  
1/8" Thickness  
x 3/8" Width x 328' Length



## Economy Fiberglass Rodding

This Economy Rodding could have applications in more dense granite materials and tight pattern granite materials.

- No Rust
- Bonds to Adhesives

SKU: WHA-8160066

**Roll size:**  
1/8" Thickness  
x 3/8" Width x 300' Length



See our complete line of structural adhesives @ [chemical-concepts.com](http://chemical-concepts.com)



# Structural Adhesives

## Chem-Set™ Fast Curing Adhesives

FOR NATURAL STONE

Work Time	Color
5-10 min	Clear/Amber
25ml	
50ml	
400ml	
FULL CURE IN 24 HOURS	

### Chem-Set™ 633 Quick Set Epoxy

SKU: CCA633

Quick set Epoxy used for porous substrates like granite, marble, concrete, wood and stainless steel surfaces. Fast Cure for undermount sink anchors.

- Thixotropic, non migrating adhesive for filling gaps
- Non sag for Vertical surfaces
- High tensile strength

OPAQUE



25ml

50ml



400ml

FOR SOLID SURFACE AND ENGINEERED STONE

Work Time	Color
3-6 min.	White/Clear
25ml	
50ml	
400ml	
FUNCTIONAL CURE	

### Chem-Set™ 605 Quick Set Acrylic

SKU: CCA605

Acrylic adhesive for use on Solid Surface, Engineered Stone, Plastics and Metals.

WHITE/CLEAR



25ml



50ml



400ml

### Chem-Set™ 650 UC Quick Set Epoxy

ULTRA CLEAR

SKU: CCA650UC

Medium viscosity, liquid epoxy system for bonding natural stone. It is excellent for seams, lamination, repairs and applications that require a UV-stable, optically-clear appearance that is suitable for interior and exterior use. This epoxy is quick setting and fast curing, with ample working and positioning times.

Work Time	Color
4 minutes	Clear
50ml Cartridge	
16 oz Kit	
Gallon	
NON YELLOWING	
FOR INTERIOR AND EXTERIOR USES	

#### 50ml Cartridge

- Includes TAH190-620 Mixing Tip
- In easy 1:1 mix ratio



50ml

#### 16 oz Kit

8 oz. each



#### 650 UC Part A&B Gallons



All these products are available in bulk packaging (1 gallon and buckets)

# Structural Adhesives

## BONSTONE®



### GLACIER KNIFE GRADE ADHESIVE



Glacier is a clear, fast-setting, UV stable adhesive designed for laminating, fabricating and bonding natural, engineered, and porcelain materials.

- Interior and exterior applications
- Zero yellowing
- Non-bleeding
- Great for: marble, granite, porcelain, & quartz stone / engineered stone
- Laminating, seaming, & more

**SKU: BON-GLACIER**

### EXPRESS II EPOXY ADHESIVE



A two-part, fast-setting, transparent epoxy used for rodding and laminating countertops.

- Knife-grade & Flowing
- Fast curing
- Mix Ratio: 2:1, Set Time: 30 min at 75 degrees
- Ideal for high humidity or freeze-thaw conditions
- Can be tinted using Touchstone Liquid Tints



**SKU: BON-EXPRESS II**

### INVISIBOND FLOWING ADHESIVE



A structural bonding epoxy for laminating and bonding countertops. With Invisibond, you will never have to return to a job site to solve adhesive problems.

- Ultra Clear Epoxy
- Stone lamination & structural bonding
- Great for: marble, granite, porcelain, & quartz stone / engineered stone
- Interior and exterior applications
- Ideal for high humidity or freeze-thaw conditions

**SKU: BON-41009**

### T-2000 KNIFE GRADE ADHESIVE



A high strength, tile adhesive that forms thick epoxy bed, which allows you to adjust tile, stone, or countertops onto uneven surfaces.

- Vertical applications: setting stone tiles and pool copings
- Strong, permanent bonds
- Adheres to stone, metal, wood, & more
- Interior and exterior applications
- Knife-grade, water cleanup
- No leaching or staining of stone

**SKU: BON-2601**

See our complete line of structural adhesives @ [chemical-concepts.com](http://chemical-concepts.com)

# Laminating and Honeycomb Epoxy

**ARALDITE® 9102** Fire-Rated Honeycomb and Laminating Epoxy  
Epoxy system for laminating natural and engineered stone to composites for production of lightweight stone panels. Great for commercial panels, elevators, air, rail, and bus panels.



Achieve high performance, thermal cycling resistance, and aging resistance with **ARALDITE® 9102** adhesive. Specially designed for higher-end panel bonding applications. Perfect for creating rigid structures when using composites and metal substrates.

### Product benefits

- High Coverage
- Easy trowel-grade consistency
- Improved Flexural Strength
- Meets flame, smoke and toxicity requirements



## Chem-Set™ Compbond 6102



Available in **1.5 Gallon Kit** and **3 Gallon Kit**  
**Convenient Pro Pail packaging for easy mix and measure**

**Compbond 6102** epoxy system for laminating natural and engineered stone to composites for production of lightweight stone panels. Great for commercial panels, elevators, air, rail, and bus panels.

Achieve high performance, thermal cycling resistance, and aging resistance with high coverage for cost savings compared to competitive products.

### Product benefits

- High Coverage
- Easy trowel-grade consistency
- Improved Flexural Strength
- Meets flame, smoke and toxicity requirements

SKU: CCA-6102A/B

## Chem-Set™ Compbond 638 Water-Clear Epoxy



Available in **3 Gallon Kit** (2 Gallon Part A, 1 Gallon Part B),  
**15 Gallon Kit** (10 Gallon Part A, 5 Gallon Part B)

**Compbond 638** is water-clear, polishable and, unlike polyester and acrylic adhesives, it will not shrink. With **Compbond 638** Clear, you'll never have to return to a job site to solve adhesive problems. It lays down a thin, tight bond line, and Bullnoses stay put. In addition it grabs, holds and sets, despite humidity or freeze/thaw conditions. You can shorten set time by applying heat. Tinting is also easy, because **Compbond 638** is a clear epoxy.

### Applications

- Honeycomb Adhesive for Lamination to Stone
- Laminating stone to other construction materials
- Countertop Fabrication
- Excellent for rodding countertops
- Stone lamination
- Stone patching, mending, repairing, and bonding

SKU: CCA638A/B-03GK



# CEL COMPONENTS

## CEL Components Honeycomb Panels

CEL COMPONENTS produces honeycomb composite sandwich panels which can be used as light-weight backer boards for thin porcelain or natural stone. These panels are available in a variety of configurations, with aluminum or fiberglass skins and even translucent panels for backlit applications.

### Realize the power of lightness in your fabrication:

- Easier installation and handling
- Improved durability & stiffness
- Reduced breakage and rework
- Reduced material and labor costs

These characteristics make our products ideal for thin porcelain fabrication, marine applications, elevator panels, facades and exterior cladding, furniture, RV & rail, ceiling panels, and high end commercial interiors.

Chemical Concepts provides a complete system including panels, specially formulated, high performance epoxy resin, and mounting solutions.

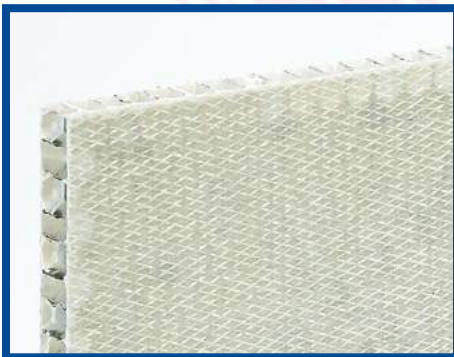

### ALUSTEP® 500

Aluminum honeycomb with fiberglass skins.



### COMPOCEL® ALP

Aluminum honeycomb with aluminum skins.



### CLEARSTEP

Translucent composite panel for backlighting.

Cel panels are available in a variety of thicknesses, sizes, materials to fit your requirements.



# Deform-Nut

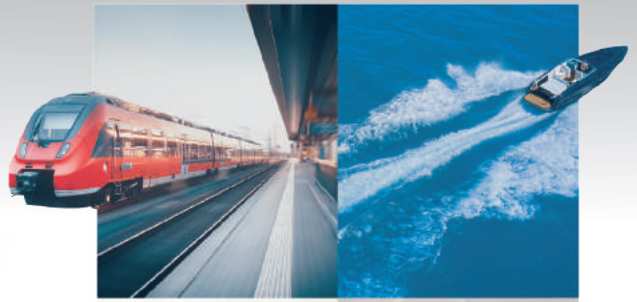

## Deform-Nut® TC/SC

**Deform-Nut® TC/DM Honeycomb Anchoring System - (Metric Imperial and Internal Thread) is a patented threaded insert system that combines mechanical anchoring and structural adhesive to provide strong load-bearing threads in sandwich panel materials (with a honeycomb or composite internal structure).**

### 3-STAGE SYSTEM



**Deform-Nut® Insert** - A special rivet nut style fastener which is riveted into the top skin of the panel using conventional rivet nut hand or air tooling



**Structural Adhesive** - Adhesive is then injected into the base of the rivet nut, which pots the insert in the honeycomb cavity



**Deform-Nut® Grub Screw** - A separate adjusting nut is then screwed into the Deform-Nut rivet nut until it bottoms out on the bottom skin, displacing the adhesive into the surrounding structure to increase load strength.



## Goebel Deform-Nut® Battery Tool GO-RN1

SKU: SPE-DNINS-B-US

GO-RN1 Cordless blind rivet nut & bolt battery tool with brushless motor for rapid installation  
Deform-nut Lithium Ion Battery Tool



- ED Light for better visibility of work area
- Control unit for optimum stroke setting + setting of the riveting mode (H/L)
- Slide-in battery (18V Li-ION 2,0 Ah / 36 Wh) with capacity indicator
- Protective housing of the underlying manual spindle unit
- Brushless motor with high durability
- Robust housing in ergonomic design w/ soft grip

## Deform-Nut® TC/DM Rivet-Nut Tool

SKU: SPE-DNINS-M

The Chem-Set Deform Nut Insertion tool is used for the Deform-Nut.

- Easy installation of inserts
- Interchangeable mandrels for compatibility with a wide variety of rivet-nuts
- Economical tool for low production volume



See our complete line of products @ [chemical-concepts.com](http://chemical-concepts.com)

# KEEP-NUT™ Sink & Panel Mount Inserts



## KEEP-NUT™ Sink Anchor Inserts for Under-Mount Sinks

KEEP-NUT™ Press-In self-anchoring sink fasteners are the strongest and most efficient mounting system for attaching undermount sinks to granite, quartz, solid surface, porcelain, and a variety of other hard surfaces. Originally designed to support building facades, vertical wall panels and furniture, the KEEP-NUT™ also offers exceptional performance for sink mounting.

- Quick Assembly by Pressure
- No Need for Resins or Adhesives
- Strongest Anchor on the Market
- Save Time & Money
- Can be drilled with standard tools (CNC, Grinder or by Hand)
- Average Strength of 562 lbs per Insert
- Crowns (or Teeth) Provide Axial Strength and Flex, Providing Higher Strength

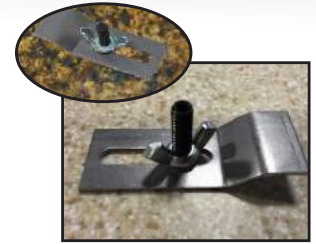

**Works on:**

- GRANITE
- MARBLE
- ENGINEERED STONE
- UHPC
- PORCELAIN
- SOLID SURFACE
- GLASS
- COMPOSITES

### Drilling Methods: CNC (All Surfaces)



### Hand Drill (Solid Surface)



### KEEP-NUT™ Drilling Machine (All Surfaces)

#### KDM115

#### KEEP-NUT™ Drilling Machine

Use 11.8 drill bits only

**CCH-KN-KDM115**  
(Vacuum Drilling Machine w/Polisher)



### Which Bit is Right for Me?

Type of Bit	Drilling Method	Surfaces
11.4mm 5/8-11 Thread Grinder Bit	KEEP-NUT™ Drilling Machine	Natural/Engineered Stone
11.8 mm 1/2 GAS CNC Bit (for CNC Routers)	CNC	Natural/Engineered Stone
11.8 mm Hand Drill / Drill Press Bit	Manual	Solid Surface/Plastics

### KEEP-NUT™ Insert & Pull-Out Strength

Part	Minimum Surface Depth(s)	Thread (d1)	Hole Depth (l2)	Hole Diameter (d2)	Threaded Post Depth (h1)	Number of Crowns	Average Pull-Out Strength
IM2S/P14-.20/H6	0.34" 8.5 mm	1/4-20	0.26" 6.5 mm	11.8 mm	0.22" 5.5 mm	2	562 lbf 2.5 kN

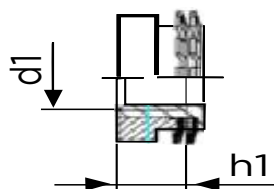

**2 Crown Type**

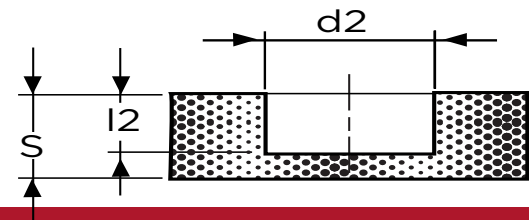

# KEEP-NUT™ Parts and Kits



**Individual Items:** As a fabricator you may want to purchase all items from us or just the **KEEP-NUT™** Inserts by themselves, see part numbers and kits below:

<b>KEEP-NUT™</b> SKU: SPE-IM1S/P1.4-20/H5		<b>1 Crown KEEP-NUT™ Insert</b> Average Strength of <b>202 lbs</b> per Insert
<b>KEEP-NUT™</b> SKU: SPE-IM2S/P1.4-20/H6		<b>2 Crown KEEP-NUT™ Insert</b> Average Strength of <b>562 lbs</b> per Insert
<b>Z-Shaped Sink Clips</b> SKU: CCH732G-250		Z-Shaped Sink Clip used to support the undermount Sink
<b>Allen Posts</b> SKU: CCH-KNPOST		1/4-20 Thread x 1-1/4" Length Male Posts Additional 1-1/2" L Post, 1/4-20 Thread sizes available 1-3/4" L Post, 1/4-20 Thread
<b>Wingnuts</b> SKU: CCH730S		1/4-20 Thread Wingnut
<b>Lock-Nuts</b> SKU: CCH734K		1/4-20 Thread Lock Nut (Optional, replaces Wingnut & Star Washer)

## Drill Bits & Installation Accessories:

<b>11.8 mm CNC Stone/Quartz Bit</b> SKU: CCH-KNBITCNC-11.8MM		11.8 mm 1/2 GAS CNC Bit for Stone/Quartz
<b>11.4 mm Manual Stone/Quartz Bit</b> SKU: CCH-KNBITGRI-11.4MM		11.4 mm Diameter, 5/8-11 thread is ideal for use with a grinder or polisher
<b>11.8 mm CNC Porcelain Bit</b> SKU: CCH-KNBITCNC-11.8-D		11.8 mm 1/2 GAS CNC Bit for Porcelain
<b>11.4 mm Manual Porcelain Bit</b> SKU: CCH-KNBITGRI-11.4-D		11.4 mm Manual Porcelain Bit 11.4 mm Diameter, 5/8-11 Thread Porcelain Bit for Drilling Machine
<b>EVO Tool Diamond Pad Drill Bit/External Gas Stem</b> SKU: SPE-FKN12X10EVO		11.5 mm Manual bit for drilling machine and SPE-FKN12X10EVO for 1/2 Gas Thread for CNC
<b>Go/No-Go Hole Tester/Depth Gauge</b> SKU: CCH-KNGAUGE		Tool used to check the diameter and depth of each drilled hole prior to pressing-in <b>KEEP-NUT™</b> (highly recommended when manually drilling)
<b>Insertion/Setting Tool</b> SKU: CCH-KNSET		Insertion tool for <b>KEEP-NUT™</b> to deflect impact from mallet when pressing <b>KEEP-NUT™</b> into surface.

## Full Sink Mounting Sets:

<b>Full KEEP-NUT™ Set</b> SKU: CCH-KEEPNUT-1/4-KIT		All items needed for <b>KEEP-NUT™</b> Sink Anchors Including: <ul style="list-style-type: none"> <li>• IM2S/P1.4-20/H6 <b>KEEP-NUT™</b></li> <li>• Z-Shaped Sink Clip</li> <li>• 1 1/4" Length Post</li> <li>• Wingnut and Washer</li> </ul>
<b>Full KEEP-NUT™ 100 pc Starter Set w/Tooling</b> SKU: CCH-KEEPNUT-STRKIT1		<b>KEEP-NUT™ 100 pc kit includes:</b> <ul style="list-style-type: none"> <li>• 100-IM2S/P1.4-20/H6 <b>KEEP-NUT™</b></li> <li>• 100-Z-Shaped Sink Clip</li> <li>• 100-1 1/4" Length Post</li> <li>• 100-Wingnut and Washer</li> <li>• Drill Bit of Choice</li> <li>• Go-No-Go Hole Tester</li> <li>• Setting Tool</li> </ul>
<b>Full KEEP-NUT™ 500 pc Starter Set w/Tooling</b> SKU: CCH-KEEPNUT-STRKIT5		<b>KEEP-NUT™ 500 pc kit includes:</b> <ul style="list-style-type: none"> <li>• 500-IM2S/P1.4-20/H6 <b>KEEP-NUT™</b></li> <li>• 500-Z-Shaped Sink Clip</li> <li>• 500-IM2S/P1.4-20/H6 <b>KEEP-NUT™</b></li> <li>• 500-Z-Shaped Sink Clip</li> <li>• Drill Bit of Choice</li> <li>• Go-No-Go Hole Tester</li> <li>• Setting Tool</li> </ul>

See our complete line of **KEEP-NUT™** parts @ [chemical-concepts.com](http://chemical-concepts.com)



# KDM115: KEEP-NUT™ Drilling Machine w/Polisher

- High-speed electric motor for improved performance on porcelain, sintered stone, and all ultra-compact surfaces
- Improved depth stop for fast and accurate drilling
- 4-point slide mechanism for improved stability
- Precise drilling in the shop or on-site
- Interchangeable parts to convert to an electric motor or air-powered version

**Use 11.4 drill bits only with  
KEEP-NUT™  
DRILLING MACHINE**



**SKU: CCH-KN-KDM115**  
(Drilling Machine w/ Electric Polisher)

**SKU: CCH-KN-KDM52**  
(Vacuum Drill Stand Only)

**SKU: CCH-KN-KDM600E**  
(Electric Drill Only)



Ventilated Facades



Under-mount Sink Anchor



Panel and Ceiling Hanging

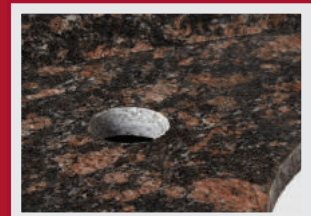

Faucet Hole Drilling



# Sink Clips and Glue-On Sink Anchors



**MOST POPULAR BONDING FASTENERS**

## Chem-Set™ BONDING FASTENERS & SINK CLIPS

Available in plated steel and stainless steel (plating meets European standards)  
Available in stainless steel, aluminum or zinc plated

### M1-B38 Undermount Sink Clips



**SKU: CCH-M1-RB38**

- 50 or 100 pcs. bagged
- Available in 3/4" or 1"
- Use with **Chem-Set™ 633** or **Chem-Set™ 605** adhesives

(see adhesives below and undermount kits on next pages)

### M1-T38 Undermount Sink Clips



**SKU: CCH-M1T38**

- 50 or 100 pcs. bagged
- Available in 3/4" or 1"
- Use with **Chem-Set™ 633** or **Chem-Set™ 605** adhesives

(see adhesives below and undermount kits on next pages)

### Chem-Set™ Z-Shaped Sink Clips



**SKU: CCH732G-100**

- Sold in box of 100
- Use with **Chem-Set™ 633** or **Chem-Set™ 605** adhesives

(see adhesives below and undermount kits on next pages)

Stainless Steel "Z" shape

### M1-B23 Undermount Sink Clips



**SKU: CCH-M1-B23**

- 50 or 100 pcs. bagged
- Available in 3/4" or 1"
- Use with **Chem-Set™ 633** or **Chem-Set™ 605** adhesives

(see adhesives below and undermount kits on next pages)

### Chem-Set™ C-Shaped Sink Clips



**SKU: CCH733G-100**

- Sold in box of 100
- Use with **Chem-Set™ 633** or **Chem-Set™ 605** adhesives

(see adhesives below and undermount kits on next pages)

Stainless Steel "C" shape

### Chem-Set™ L-Shaped Sink Clips



**SKU: CCH735G**

- Sold in box of 100
- .75" x 2" x .08"
- Use with **Chem-Set™ 633** or **Chem-Set™ 605** adhesives

(see adhesives below and undermount kits on next pages)

Stainless Steel  
"L" shape

### Chem-Set™ L-Shaped Sink Clips



**SKU: CCH736G-100**

- Sold in box of 100
- .75" x 1.5" x .08"
- Use with **Chem-Set™ 633** or **Chem-Set™ 605** adhesives

Stainless Steel "L" shape

### Chem-Set™ L-Shaped Sink Clips



**SKU: CCH737G-100**

- Sold in box of 100
- 1.25" x 1.5" x .08"
- Use with **Chem-Set™ 633** or **Chem-Set™ 605** adhesives

Stainless Steel  
"L" shape

**Sink clips and accessories used – See each page for recommended gun to use with adhesive**

## No Drilling Adhesives

### Chem-Set™ 633

#### Quick Set Epoxy

Quick Set Epoxy for use on porous substrates like Granite, Marble, Concrete and Wood.

- Available in 25 ml & 50 ml

**SKU: CCA633**

OPAQUE



FOR NATURAL STONE

### Chem-Set™ 605

#### Quick Set Acrylic

Acrylic adhesive for use on Solid Surface, Engineered Stone, Plastics and Metals.

- Available in 25 ml & 50 ml

**SKU: CCA605**

WHITE/CLEAR



FOR SOLID SURFACE AND ENGINEERED STONE

Most popular bonding fasteners and sizes illustrated. See website for our complete line of fasteners @ chemical-concepts.com

# Glue-On Sink Anchor Kits cont'd

## Chem-Set™ Undermount Kits For Natural Stone Surfaces and Engineered Stone



### Chem-Set™ CCH744K SKU: CCH744K

KIT INCLUDES: CCH744K
(1) 1" Threadlocker Post
(1) Wingnut
(1) Female Anchor

FOR NATURAL STONE



- Use with natural stone (granite, marble, concrete, wood)

### Chem-Set™ CCH755K SKU: CCH755K

FOR NATURAL STONE



KIT INCLUDES: CCH755K
(100) M1-RB38-1/4-20x1.00" Studs
(100) Z-Shaped Sink Clips
(100) Wingnuts
(100) Washers

- Use with natural & engineered stone, or any solid surface top

## Undermount Sink Brackets

### Sinkits® Sink Mounting Clamp

- Clamp design for undermounting sinks to granite, quartz, concrete or any other stone or hard surface material
- Universal design works with all type sinks up to 3/4" thick rim
- Very strong – supports up to 117 pounds each

SKU: SIN-0911-48



### T31 TBolts Mechanical Flat Head Anchor

- 3/16" x 1 1/2"
- Stainless Steel
- Comes with nut and washer
- Anchoring system for undermount sinks
- 100 pcs. bagged

SKU: CCH-T31-3/16-1-1/2



### Sinkits® LC Low Clearance Undermount Sink Brackets

- Designed to be installed into the cabinet and bend to meet the underside of the sink rim
- Each pair includes: (2) Brackets and (4) Screws
- Works when there is no room to drill a hole / cut a slot
- Great for repairs to fallen sinks
- Brackets can bend up to 45 degrees to meet space requirements

SKU: SIN-LC0915



See our complete line of products @ [chemical-concepts.com](http://chemical-concepts.com)

### VANSEAL Sink Undermounter FULLY ADJUSTABLE AND REMOVABLE

- 25", 36", and 50" lengths easily trim to fit any cabinet size
- Eliminates the need for wood support
- Use side/side or front/back
- Hardware supplied for all installations
- Includes 2 rails, 4 mounting clips, 8 adjusting bolts/nuts, 2 joiner clips
- Sink Overflow Clips accessory: allows support for bowls with overflows with 2 sets of sink undermounters (includes 2 sliding clips, 2 adjusting bolts/nuts)

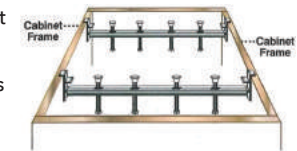

SKU: VAN-QN-UM

## Dishwasher Mounting Bracket

### E-Z Dishwasher Bracket™

Available in 24" length



- Easy installation under any type of counter top
- Can be installed prior to or after counter top installation
- Dishwasher does not have to be present
- Made in USA from 22 gauge galvanized steel
- Available in 26 1/2" or 18" length

SKU: CCH-DWBAR

# CounterBalance® Cabinetry Overhangs



**POWDER COATED**

## CounterBalance® ISLANDBAR (24")

<b>Material</b>	High Strength Steel (HRPO Steel*)
<b>Overhang Support</b>	Supports 18" overhangs
<b>Mounting Holes</b>	2 Mounting Holes
<b>Width</b>	1 ½" (38.1 mm)
<b>Height</b>	1 ½" (38.1 mm)
<b>Length</b>	24" (610 mm) long
<b>Thickness</b>	7 GA

**SKU: CCH-CBIB2**

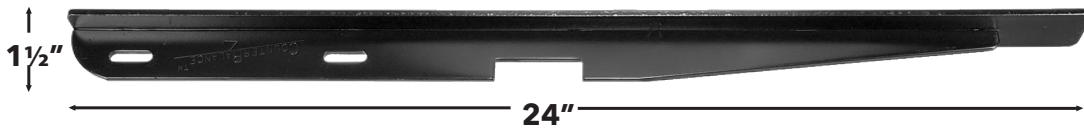

**POWDER COATED**

- Corners are rounded for safety
- Available in kits of 3

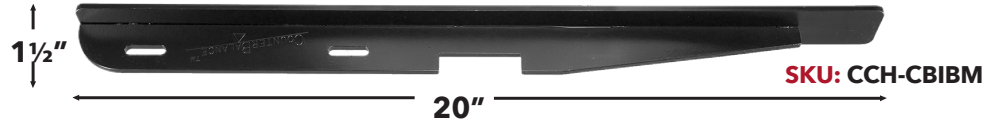

**SKU: CCH-CBIBM**



## CounterBalance® ISLANDBAR MINI (20")

<b>Material</b>	High Strength Steel (HRPO Steel*)
<b>Overhang Support</b>	Supports 15" overhangs
<b>Mounting Holes</b>	2 Mounting Holes
<b>Width</b>	1 ½" (38.1 mm)
<b>Height</b>	1 ½" (38.1 mm)
<b>Length</b>	20" (508 mm) long
<b>Thickness</b>	7 GA



See our complete line of CounterBalance® products @ [chemical-concepts.com](http://chemical-concepts.com)

# CounterBalance® Flat Plates and Half-Wall Overhang Brackets

POWDER COATED



SKU: CCH-CBP

## CounterBalance® COUNTERPLATE

<b>Material</b>	High Strength Steel (HRPO Steel*)
<b>Overhang Support</b>	Supports 13" overhangs
<b>Mounting Holes</b>	3 Mounting Holes
<b>Width</b>	3 3/4" (95.25 mm)
<b>Length</b>	9 3/4" (247.7 mm)
<b>Thickness</b>	7 GA

POWDER COATED



SKU: CCH-CBPL

## CounterBalance® COUNTERPLATE XL

<b>Material</b>	High Strength Steel (HRPO Steel*)
<b>Overhang Support</b>	Supports 15" overhangs
<b>Mounting Holes</b>	3 Mounting Holes
<b>Width</b>	3 3/4" (95.25 mm)
<b>Length</b>	11 3/4" (298.5 mm)
<b>Thickness</b>	7 GA

POWDER COATED

SKU: CCH-CBxB2

AVAILABLE COLOR:  Black



## CounterBalance® CROSSBAR (24" x 24")

<b>Material</b>	High Strength Steel (HRPO Steel*)
<b>Overhang Support</b>	Supports 18" overhangs
<b>Mounting Holes</b>	2 Mounting Holes
<b>Width</b>	1 1/2" (38.1 mm)
<b>Height</b>	1 1/2" (38.1 mm)
<b>Length</b>	24" x 24" length (610 mm x 610 mm)
<b>Thickness</b>	7 GA

POWDER COATED

SKU: CCH-CBxBM2

AVAILABLE COLOR:  Black



## CounterBalance® CROSSBAR MINI (18" x 18")

<b>Material</b>	High Strength Steel (HRPO Steel*)
<b>Overhang Support</b>	Supports 15" overhangs
<b>Countersink Holes</b>	2 Mounting Holes
<b>Width</b>	1 1/2" (38.1 mm)
<b>Height</b>	1 1/2" (38.1 mm)
<b>Length</b>	18" x 18" length (457.2 mm x 457.2 mm)
<b>Thickness</b>	7 GA

See our complete line of CounterBalance® products @ [chemical-concepts.com](http://chemical-concepts.com)



# CounterBalance® Float Frame Brackets

**NEW**

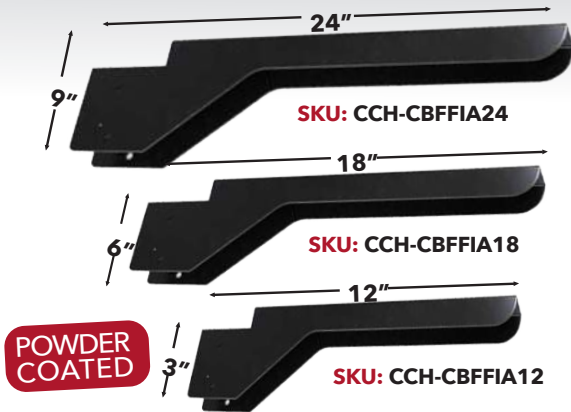

## CounterBalance®

### FLOAT FRAME Island Arm

<b>Material</b>	High Strength Steel (HRPO Steel*)
<b>Overhang Support</b>	Supports 12", 18" & 24" overhangs
<b>Mounting Holes</b>	3 Mounting Holes
<b>Width</b>	3" (95.25 mm) 6" (152.4 mm) 9" (228.6 mm)
<b>Length</b>	12" (304.8 mm) 18" (457.2 mm) 24" (610 mm)
<b>Thickness</b>	12 GA

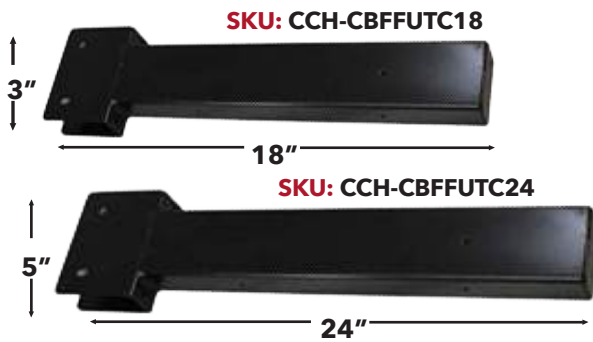

## CounterBalance®

### FLOAT FRAME Under-The-Counter

<b>Material</b>	High Strength Steel (HRPO Steel*)
<b>Overhang Support</b>	Supports 18" & 24" overhangs
<b>Mounting Holes</b>	3 Mounting Holes
<b>Width</b>	3" (95.25 mm) 5" (127 mm)
<b>Length</b>	18" (457.2 mm) 24" (610 mm)
<b>Thickness</b>	12 GA

POWDER COATED



See our complete line of CounterBalance® products @ [chemical-concepts.com](http://chemical-concepts.com)

# CounterBalance® Floating Countertop Brackets



## CounterBalance® CONCEALED BRACKETS

- Low-profile brackets provide a clean, "floating" look for your countertop
- Available lengths: 9", 12", 18", and 24"
- Supports should be placed every 16" to 20"
- Available colors: white, black, grey and almond

Pictured: 18"

SKU: CCH-CBCB

AVAILABLE COLORS:



White, Black, Grey and Almond



## CounterBalance® EXTENDED CONCEALED BRACKETS

- Low-profile brackets provide a clean, "floating" look for your countertop
- Available lengths: 9", 12", 18", and 24"
- Supports should be placed every 16" to 20"
- Available colors: white, black, grey and almond

Pictured: 9"

SKU: CCH-CBCBE

AVAILABLE COLORS:



White, Black, Grey and Almond



## CounterBalance® CONCEALED FLAT BRACKETS

- Load limit range of 1400 lbs to 4900 lbs per pair
- Mounting hardware included
- Available lengths: 9", 12", 18", and 24"
- Supports should be placed every 16" to 20"
- Available colors: white, black

Pictured: 24"

SKU: CCH-CBCF

AVAILABLE COLORS:



White and Black



SKU: CCH-CBCFE

AVAILABLE COLORS:



White and Black

Pictured: 24"

## CounterBalance® EXTENDED CONCEALED FLAT BRACKETS

- Upper extension (above the support arm) provides superior strength
- Load limit range of 1400 lbs to 4900 lbs per pair
- Mounting hardware included
- Available lengths: 9", 12", 18", and 24"
- Supports should be placed every 16" to 20"
- Available colors: white, black



See our complete line of CounterBalance® products @ [chemical-concepts.com](http://chemical-concepts.com)

# CounterBalance® Floating Countertop Brackets



## CounterBalance® WORKSTATION BRACKETS

- Handicap accessible vanities and workstations
- Stone and solid surface
- Weight Bearing Shelving
- 1/8" steel construction
- Very strong - exceeds - 1,000 lbs load limit
- 1 1/2" mounting surface with multiple 1/4" holes per side
- Standard color textured powder coat finishes

### AVAILABLE COLORS:



Black, White, Gray, Almond, Stainless Steel and Pre-primed for your own finish

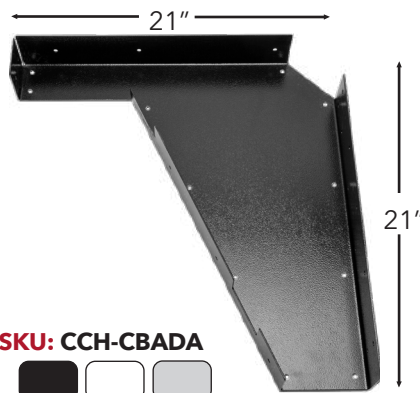

### SKU: CCH-CBADA



Black, White, Stainless Steel

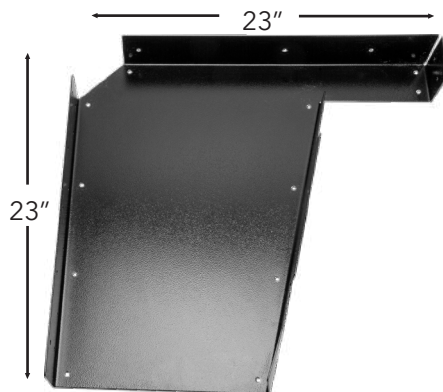

## CounterBalance® ADA VANITY BRACKETS

- 12 Gauge Steel offers superior strength
- Optional mounting holes on sides of Black Brackets to install your finishing panel if desired
- Accommodates 22" to 26" deep countertops
- No visible fasteners
- No tools required to remove & reinstall skirt
- Mounting holes provided
- 3x3 cut out for wall cleat & wire run clearance
- Standard color textured powder coat finishes: Black, white, gray, stainless steel and pre-primed for your own finish
  - 21" length 533.4mm
  - 22" height 558.8mm
  - 3" width 76.2mm
  - 23" length 584.2mm
  - 22" height 558.8mm
  - 3" width 76.2mm
- Available in the US or Import

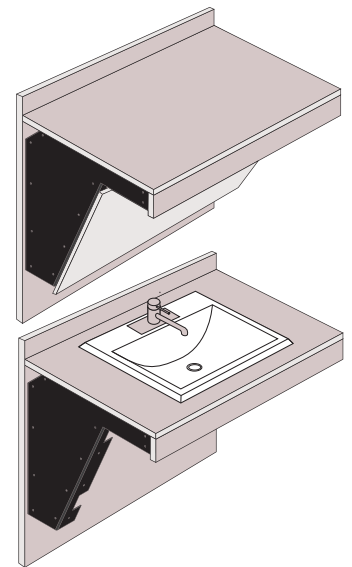

See our complete line of CounterBalance® products @ [chemical-concepts.com](http://chemical-concepts.com)

# CounterBalance® Floating Countertop Brackets



- 1.0" or 1.5" T and 9", 12", 18", and 24" support arms
- Load limit range of 525 lbs. to 2,200 lbs. per pair
- Available in black and white powder coat

**SKU: CCH-CBHB**



## CounterBalance® HYBRID BRACKET

<b>Width</b>	1" or 1 1/2" (38.1 mm)
<b>Height</b>	1 1/2" (38.1 mm)
<b>Length</b>	18" x 18" & 18" x 24" lengths

- Finishing caps provided

## CounterBalance® HEAVY DUTY HYBRID BRACKET

<b>Width</b>	3" (72 mm)
<b>Height</b>	1" (24 mm)
<b>Length</b>	18" x 18" & 24" x 24" lengths

- Recommended double stud for bracket attachment
- Brackets available in black and white powder coat
- Available with 18" or 24" support arm
- 18" tall x 18" projection x 3" wide and 24" tall x 24" projection x 3" wide
- 1700 lbs./pr 18", 1350 lbs. /pr 24"
- Packed: 2 Per Box
- Finishing caps provided

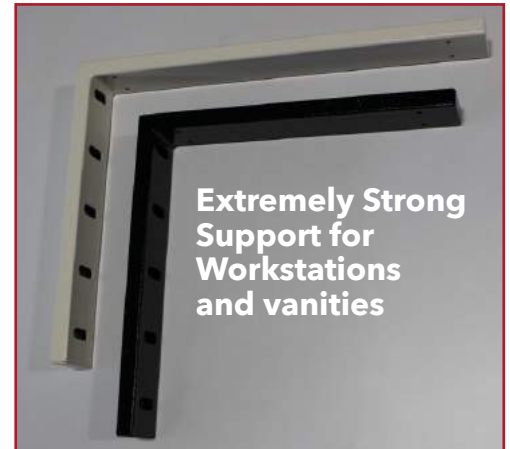

AVAILABLE COLORS:    
White and Black

**SKU: CCH-CBHDHYB**

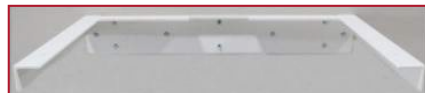

## CounterBalance® FLOATING VANITY BRACKETS

<b>Material</b>	.25" Steel—Extremely Strong
<b>Overhang Support</b>	Supports 18" overhangs
<b>Load limit</b>	1100 lb load limit
<b>Tall</b>	2" (50.8 mm)
<b>Wide</b>	28" (711.2 mm)
<b>Projection</b>	18" (457.2 mm) arm projection

- Blocking across back plate recommended
- 1 pc/21 lbs

See our complete line of CounterBalance® products @ [chemical-concepts.com](http://chemical-concepts.com)



# CounterBalance® Shelving Brackets



\*sold in pairs

**SKU: CCH-CBFS**

AVAILABLE COLOR:  White



**SKU#'s for available sizes:**

- SKU: CCH-CBFS6-IM** 2 pc/3 lbs
- SKU: CCH-CBFS9-IM** 2 pc/4 lbs
- SKU: CCH-CBFS12-IM** 2 pc/5 lbs

## FLOATING SHELF BRACKETS

### CounterBalance®

<b>Material</b>	.25" Steel—Extremely Strong
<b>Tall</b>	1 ¾" (44.45 mm)
<b>Thickness</b>	.25" thick (6.35 mm)
<b>Wide</b>	1 ½" (38.1 mm)
<b>Length</b>	6", 9" and 12" lengths

- **Load Limit:** 2000 lbs/pr 6", 1500 lbs/pr 9" and 1000 lbs/pr 12"
- Brackets must be mounted directly to the stud for maximum strength
- Mounting hardware will fail before bracket
- Brackets can be hidden in a boxed shelf

## HIDDEN SHELF BRACKETS

### CounterBalance®



**SKU: CCH-CBHS**

AVAILABLE COLOR:  White



<b>Material</b>	.25" Steel—Extremely Strong
<b>Tall</b>	1 ½" (38.1 mm)
<b>Thickness</b>	.25" thick (6.35 mm)
<b>Wide</b>	20" (508 mm)
<b>Length</b>	6", 9" and 12" lengths

- **Load Limit:** 450 lbs/pr 6", 400 lbs/pr 9" and 350 lbs/pr 12"
- Blocking across back plate recommended
- Brackets can be hidden in a boxed shelf

**SKU#'s for available sizes:**

- SKU: CCH-CBHS6** 1 pc/5 lbs
- SKU: CCH-CBHS9** 1 pc/7 lbs
- SKU: CCH-CBHS12** 1 pc/8 lbs

See our complete line of CounterBalance® products @ [chemical-concepts.com](http://chemical-concepts.com)

# CounterBalance® Surface, Stair & Cleat Brackets



SKU#'s for available sizes:

SKU: CCH-CBSF6      SKU: CCH-CBSF12  
SKU: CCH-CBSF9      SKU: CCH-CBSF15

## CounterBalance® SURFACE MOUNTED FLAT BRACKET

<b>Material</b>	Black powder coated steel
<b>Mounting Holes</b>	4 Mounting Holes
<b>Size</b>	6" 9" 12" and 15"
<b>Thickness</b>	1/2" thick steel

- A simple, strong and attractive alternative for floating shelves
- 1/2" thick material with 1/4" mounting holes
- Also available is Stainless steel and Aluminum, both brushed with clear finish



SKU: CCH-CBST10

## CounterBalance® STAIR TREAD BRACKET

<b>Material</b>	Black powder coated steel
<b>Mounting Holes</b>	3 Mounting Holes
<b>Size</b>	10" by 2" support
<b>Thickness</b>	1/4" thick steel

- Heavy duty support for industrial style design treads
- Can be mounted either direction



SKU#'s for available sizes:

SKU: CCH-CBCLT28      SKU: CCH-CBCLT90  
SKU: CCH-CBCLT44

## CounterBalance® CLEAT SUPPORT BRACKET

<b>Material</b>	Black powder coated steel
<b>Mounting Holes</b>	Holes offset at 8 inch intervals
<b>Size</b>	28", 44" and 90"
<b>Thickness</b>	1/4" thick steel

- Black Powder coated metal
- Countertop support for side walls and along back edge



SKU: CCH-CBISLB3-15

## CounterBalance® ISLAND BRACKET

<b>Material</b>	Black powder coated steel
<b>Mounting Holes</b>	10 or 16 holes, offset at 1.3" intervals
<b>Size</b>	15", 34" and 40"
<b>Thickness</b>	1/2" thick steel

See our complete line of CounterBalance® products @ [chemical-concepts.com](http://chemical-concepts.com)

# Sealers and Cleaners



by DRYTREAT

WORLD LEADING SEALERS FOR THE PROTECTION OF NATURAL STONE, TILES, PAVERS CONCRETE, BRICKS AND GROUT.



## Dense Stone Impregnating Sealer

*Previously known as Stain-Proof™ Plus*

Impregnating, invisible and breathable sealer that protects natural stone countertops from damage.

- Made for man-made stone pavers
- Intense color enrichment with oil and water repellency
- Fully impregnating, with no sheen or shine

25 YEAR WARRANTY

SKU: DRY110712



## Premium Impregnating Sealer

*Previously known as STAIN-PROOF ORIGINAL™*

Permanent-bonding impregnating sealer designed for use as premium stain protection.

- Premium permanent stain protection
- Superior oil and water repellence
- Retains natural surface and color
- Stands up to commercial cleaning methods

15 YEAR WARRANTY

SKU: DRY110513



## Porcelain & Quartz Sealer

*Previously known as PORCELAIN PLUS*

Specifically designed for porcelain and quartz surfaces.

- Seals micro pores unpolished porcelain and quartz surfaces
- Creates a unique molecular bond
- Permanent, long lasting protection

10 YEAR WARRANTY

SKU: DRY110600



## Daily Countertop Cleaner

*Previously known as REJUVENATA™ SPRAY*

A gentle daily cleaner for natural and engineered stone countertops used to keep countertops looking their best.

- Powerful, natural active enzyme cleaner
- For interior and exterior uses
- Hydrogen peroxide based
- For extra cleaning power, add SMC Peroxide Cleaner Additive!

SKU: DRY141112



## Acidic Cleaner

*Previously known as EFF-ERAYZA™*

Removes efflorescence grout haze, rust marks, limescale, soap scum, fireplace soot and mortar residue.

- The power of Muriatic acid without the fumes
- Chemically etches acid sensitive surfaces for added traction

SKU: DRY141942



## Alkaline Cleaner

*Previously known as OXY-KLENZA™*

A powerful triple action, oxygen, alkaline and detergent boosted heavy duty cleaner for removal of stains caused by oil / grease, mold, leaf marks, food and beverages.

- Up to 500 sq. ft. of peroxide cleaning power

SKU: DRY141212



## 40SK Consolidator & Water Repellent

*Previously known as Dry Treat 40SK)*

Deep color enhancement and premium stain protection.

- Designed for indoor and outdoor surfaces
- Breathable: water vapor escapes freely, avoiding moisture build-up inside the material
- Deep penetration and long lasting

15 YEAR WARRANTY

SKU: DRY123142



## SMC Peroxide Cleaner & Additive

*Previously known as S-TECH STONE & MASONRY CLEANER™ and SMC BOOST*

Penetrating, foaming dirt lifting action.

- For organic stains
- Ideal for historic preservation
- For interior and exterior uses
- Hydrogen peroxide based
- Add for extra cleaning power!

SKU: DRY152000



## Paver Enhancing Sealer

Offers both rich both rich color enhancement and water and liquid protection through a patented combination of silicone technology.

- Long-lasting, penetrating oil and water repellent
- Deepens and enriches the natural color of concrete pavers, cement tiles, terrazzo floors and cement surfaces

SKU: DRY1508

See our complete line of sealers and cleaners @ [chemical-concepts.com](http://chemical-concepts.com)





# ADVANCED HYBRID ADHESIVE

Most eco-friendly adhesives don't have the strength to get the job done. BoaBond Fast Cure offers an eco-friendly option that is made to perform on a wide variety of substrates.

- ✓ INNOVATIVE HYBRID TECHNOLOGY
- ✓ VOC COMPLIANT
- ✓ PERMANENTLY FLEXIBLE
- ✓ BONDS TO WET SURFACES

## BOABOND FEATURES

- Fast grab adhesive for easy vertical installation
- High strength, tough, durable bonds
- No solvents or Isocyanates for VOC compliance
- Bonds wet or damp materials
- Can be applied overhead with no sag
- 100% solids, will not shrink
- Fast cure offers immediate green strength
- Adheres to a wide variety of substrates
- Permanently flexible; allows for vibration & movement





# Sealants

## HYBRID SEALANTS



### Integra Adhesives TopSeal

Integra Adhesives TopSeal is a premium performance MS Polymer that can be used as an assembly adhesive and a surface sealant. TopSeal comes standard in 6 colors, is food safe, and hardens after cure.

- 100% Waterproof Joint Sealant
- Excellent gap filling properties
- Does not yellow and change color over time like silicone
- High shore hardness making it easy to clean
- Non-bleeding

AVAILABLE COLORS:



- SKU: INTSL300WHITE WHITE
- SKU: INTSL300IVORY IVORY
- SKU: INTSL300MAGNOL MAGNOLIA
- SKU: INTSL300VALEN VALENZA
- SKU: INTSL300FOSSGR FOSSIL GREY
- SKU: INTSL300BLACK BLACK



### Chem-Set™ MS-35 "Silicone on Steroids"

Chem-set MS-35 is a one-component, high early green strength, high performance, non-sag, multi-purpose elastomeric, silyl-terminated polyether adhesive and sealant. MS-35 is a great alternative to 100% RTV Silicones (like RTV4500) in that the MS-35 combines the sealing capabilities of a silicone but also provides the strength of a construction adhesive.

- Available in 10.3 standard caulking cartridge
- 2 times the bond strength of silicone-Lapshear 250-330 PSI
- 100% VOC HAPS/Compliant -75°F to 250°Fb(operating temp range)
- Bonds to most substrates without priming

AVAILABLE COLORS:



- SKU: CCS-MS35-UC-10OZ ULTRA CLEAR
- SKU: CCS-MS35-WT-10OZ WHITE

## SILICONIZED ACRYLIC LATEX



### Chem-Set™ PB-3

Peri-Bond (PB-3) is a premium quality one component, paintable, non-sag, low odor, mildew resistant siliconized acrylic latex sealant that is formulated to provide a long-lasting interior and exterior seal where slight to no movement is expected.

- One-component, latex sealant
- Paintable, mildew resistant and non-yellowing
- Water clean up
- Exterior/Interior Use
- Mildew Resistant
- Non-Staining
- Low Dirt Pickup

AVAILABLE COLORS:



- SKU: CCS-PB3-CLEAR
- SKU: CCS-PB3-WHITE

## POLYURETHANE CONSTRUCTION ADHESIVE



### SikaFlex 1A Construction Sealant

Sikaflex-1a is a premium-grade, high-performance, moisture-cured, 1-component, polyurethane-based, non-sag elastomeric sealant made to seal joints around windows, door frames, flashings and much more.

- Non-sag elastomeric sealant
- Excellent resistance to aging, weathering paintable
- Certified NSF/ANSI standard for potable water and jet fuel resistant
- High elasticity

AVAILABLE COLORS:



- SKU: SIK91017 WHITE
- SKU: SIK91013 COLONIAL WHITE
- SKU: SIK91009 ALUMINUM GRAY
- SKU: SIK91011 BLACK

See our complete line of adhesive sealants @ [chemical-concepts.com](http://chemical-concepts.com)

# Silicone - 100% RTV

## Chem-Set™

### RTV3500 & RTV4500

Chem-Set™ RTV 4500 is a one component room temperature vulcanizing (RTV) industrial/construction grade silicone sealant and adhesive that has been chemically formulated for high strength adhesion.

- High Strength
- Excellent Weatherability
- UV Stable
- Non-Yellowing
- VOC Compliant
- Non-Flammable
- Waterproof
- Excellent Adhesion
- Non-Shrinking

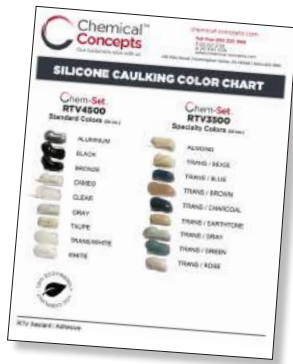

### Chem-Set™ RTV3500

Available Colors:



- ALUMINUM
- BLACK
- BRONZE
- CAMEO WHITE
- CLEAR
- GRAY
- TAUPE
- TRANS/WHITE
- WHITE

### Chem-Set™ RTV4500

Available Colors:



- ALMOND
- TRANS/BEIGE
- TRANS/BLUE
- TRANS/BROWN
- TRANS/CHARCOAL
- TRANS/EARTHTONE
- TRANS/GRAY
- TRANS/GREEN
- TRANS/ROSE

## Chem-Set™ RTV-7500 Neutral Cure Silicone



One component, low modulus, neutral cure silicone sealant and adhesive created to bond a wide variety of building materials.

AVAILABLE COLORS:



SKU: CCS-RTV7500

- Non-bleeding/staining on quartzites and marbles
- Multi-Surface
- Excellent Adhesion
- Non-Corrosive
- Low Odor
- 50% Movement Capability
- Permanent Flexibility
- Excellent Weatherability
- Long Life

	Work Time	Color
Size	10.3 Cartridge	
Gun	250 GUN Thrust Caulk Gun 18:1	
	SKU: NEW-250 250 ml	
Cure	Tack time: 2 hours. Full Cure: 24 hours.	

## Sika GP -101 formerly Bondaflex 100



SikaSil-GP is a general-purpose, one-component, non-sag, elastomeric, 100% RTV acetoxy silicone sealant.

AVAILABLE COLORS:



SKU: SIK56

- One-component ready to use
- Excellent for dynamic joint movement & dissimilar materials, Joint movement ±25%
- Excellent adhesion, bonds to many substrates without priming
- Fast Cure - Move assembled or sealed parts quickly

	Work Time	Color
Size	10.3 Cartridge	
Gun	250 GUN Thrust Caulk Gun 18:1	
	SKU: NEW-250 250 ml	
Cure	Tack time: 2 hours. Full Cure: 24 hours.	

See our complete line of adhesive sealants @ chemical-concepts.com

# Chip Repair Kits

## Chem-Set™ Chip Repair Kit

The Chem-Set **800** Chip Repair Kit repairs scratches, chips, holes, cracks, nicks, and fissures in stone quickly, making it perfect on on-site repairs. Ideal for natural stones, such as granite or marble.

### PERMANENT REPAIR

- Quickly repairs chips, gouges, and small cracks on the job.
- Does not fracture or crack.
- Non-yellowing, UV stable.
- For Shop Use or Retail\*



Packaging

### KIT INCLUDES: CCA800

(1 oz) Bottle of Thin Set (**CA5**)

(1 oz) Bottle of Thick Set (**CA2400**)

(2 oz) Bottle of QuickTac  
2 'Low Bloom' Activator



SKU: CCA800

## Chem-Set™ Low Bloom Chip Repair Kits

The Chem-Set Low Bloom **801** and **802** Chip Repair Kits come with our new 'Low Bloom' Stone-Tac Activator which significantly decreases the occurrence of stone blooming or "greening" compared to the standard CA (super glue) kits out there today.

These kits allow you to make a variety of repairs on natural and engineered stone surfaces, with a significantly decreased chance of blooming or stone discoloration. • For Shop Use or Retail\*



### Chem-Set™ Stone Tac 801 Kit

#### KIT INCLUDES: CCA801

(1 oz) Bottle of Thin Set (**CA5**)

(1 oz) Bottle of Thick Set (**CA-2400**)

(6 oz) Aerosol Can of Stone-Tac 'Low Bloom' Activator



SKU: CCA801

Repair chips, gouges and small cracks on your stone surfaces.

### Chem-Set™ Stone Tac 802 Kit

#### KIT INCLUDES: CCA802

(1 oz) Bottle of Thin Set (**CA5**)

(1 oz) Bottle of Medium Set (**CA-100**)

(1 oz) Bottle of Thick Set (**CA-2400**)

(6 oz) Aerosol Can of Stone-Tac 'Low Bloom' Activator



SKU: CCA802



\*Private Labeling Available



# Chip Repair Kits

## Chem-Set™ UV Stone Repair Kits

ChemSet™ **UV Stone Repair Kits** are used when a fast permanent repair is needed to fix scratches, chips, gouges, holes, cracks and nicks on natural and engineered stone. Fast repairs can be completed in less than three minutes, the manufacturer reports. No More Discoloration/Blooming Issues! This easy-to-use UV Kit uses a UV light to cure the adhesive. Without the use of an activator spray as a curing agent you will never have issues with blooming again. Great for your lighter colored stones and marbles.

### Chem-Set™ UV Stone Repair 10ml Consumer Kit



<b>KIT INCLUDES: CCA900</b>
1 (10ml) Bottle <b>UV386</b>
4 Cure sheets
2 Polish packs
1 LED keychain light
2 Straight edge razors

**SKU: CCA900**



### Chem-Set™ UV Stone Repair 50ml Pro Kit



<b>KIT INCLUDES: CCA951</b>
1 (50ml) Bottle <b>UV386</b>
15 Cure sheets
15 Polish packs
1 Large LED Flashlight
3 AAA batteries
5 Straight edge razors

**SKU: CCA950**



**5x** the value of leading competitors!

Our 10ml bottles are 5x the size of their 2ml syringes.



**VS**



# Porcelain Scratch Repair



## Porcelain Scratch Repair Kit

SurfaceRenu™ offers a full line of products for the removal of scratches, and damage from most types of polished ceramic surfaces.

SurfaceRenu is the industry's premier solution for rapid scratch removal from polished ceramic without leaving trace marks or creating distortion. Our Professional Grade System is designed to repair the most common types of ceramic damage, by providing the operator a simple, effective way to quickly restore damaged ceramic to "like-new" condition. The system features simple-to-follow instructions and everything required except a sander/polisher.

Every Professional Grade System includes high quality and reliable components, offering unparalleled speed and success in repairing damaged ceramic.



### The SurfaceRenu Professional Grade System is a complete solution and includes:

- High-end custom made backing pads—3" & 5"
- 40 RenuDisks®
- 2ct 5" Polishing felts
- 1—bottle of Light & Dark Polish Compound
- Rasp file
- Dust mask
- Easy to follow instructions

### RenuDisks®

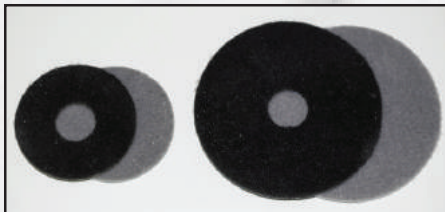

RenuDisks are available in two sizes (3" and 5") in two grinding ranges to match the type of surface damage being repaired.

The patented design and construction are proprietary to SurfaceRenu and available only through SurfaceRenu and Authorized SurfaceRenu Resellers. The disks employ a special construction that allows for rapid scratch removal from polished ceramic without leaving trace marks or discernible distortion – even on deep damage.

Instructions on when to use a particular disk size or grinding range are included with every SurfaceRenu System. The disks are color-coded for quick identification and ease of use. Selection by color helps to take the guesswork out of the scratch removal process.

### RenuDisk Grinding Range Color Key:

- BLACK** Used for all damage that catches a fingernail
- GREY** Used to remove damage you can't feel with your fingernail and for Pre-polish

SKU: SRN-108-1000

### Surface Renu Polishing Compound

Each Professional Grade System comes with a bottle of SurfaceRenu's proprietary advanced formula Polishing Compound. We take rare earth mineral polish to a whole new level by refining and milling our own blend of polishing compounds to achieve the highest quality surface finish. One bottle of polish, filled with clean water to the top, will allow the user to polish up to 400 square feet of light damage from the ceramic surface.

- For Shop Use or Retail



See our complete line of SurfaceRenu™ products @ [chemical-concepts.com](http://chemical-concepts.com)



# Tape and Surface Protection Film

## Chem-Set™ Blue Painters Tape

The environmentally safe painter's tape will cleanly remove from most surfaces for up to 21 days, leaving clean, crisp paint lines.

**SKU: CCT-P621**

- Comes in sizes from 3/4" to 3"
- Works on a variety of surfaces
- Designed to prevent dry out or keep its holding power

60YD ROLLS

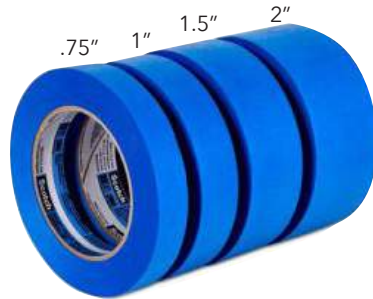

## Alpha G-Tape

G-Tape is a patented combination of solvent acrylic adhesive with an advanced backing substrate that results in unmatched performance.

**SKU: CCT-GT1009GR-2**

- Waterproof
- Repositionable
- Great for quick repairs
- Hard surface protection
- Weather and UV resistant
- 2" X 163' (60 yds) multi-purpose tape
- Hand tears, straight and easy

60YD ROLLS



## Chem-Set™ Masking Tape 5.0 mil

This all purpose masking is primarily used for general purpose bundling, packaging, protecting, and splicing.

**SKU: CCT-P217**

- Coated with natural rubber adhesive
- Excellent adhesive
- Temperature resistant
- Cream color



60YD ROLLS

## Chem-Set™ Poly Film Mitre Tape

This 7 mil tape is excellent for mitreing offering the perfect combination of strength and durability.

**SKU: CCT-P74-2C**

- Use for mitring
- 7 mil. Clear
- Size 2" X 60'



## tesa™ Precision Mask

**tesa® 4334 3.5 mil (.0035")**

**SKU: TES-4334**

The tesa Precision Mask 4334 reliably guarantees razor-sharp paint edges, and is extremely easy to use

- Yellow precision masking tape
- Suitable for precise applications
- Guarantees very sharp-edged finishing
- Suitable for delicate surface

55YD ROLLS

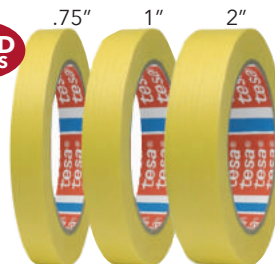

## Chem-Set™ Foil Tape 3.0 mil

Aluminum Foil/Acrylic Adhesive

**SKU: CCT-AF30SW-2**

- Surface film protection
- Used for waterproofing, vapor barrier, and air leakage protection
- High reflectivity assures effective heat, light interference, and electrical insulation shielding
- Designed to stick firmly to it's own backing
- Great for installing cook tops in solid surface
- Premier product for masking in paint stripping and electroplating

60YD ROLLS



## Chem-Set™ 3.0 mil Surface Protection Film

**SKU PRES30L40**

medium/high tack, 3 mil thick 24" x 600'

**SKU PRES30L40-30**

medium/high tack, 3 mil thick 30" x 600'

- Protect counters and porcelain/marble and granite pieces from damage during storage construction, and transportation
- Can be safely applied to the surface without damaging the counter or leaving residue
- Good for use on flat surfaces

600 Foot Rolls

**Available Sizes**  
Film 24" x 600' • 30" x 600'



See our complete line of Chem-set™ tapes @ chemical-concepts.com



# Hot Melt Adhesives

## Chem-Set™ Hot Melt Adhesives & Dispensing Guns

### Chem-Set™ 735 Hot Melt

**SKU: FPC735R10, R15**

**Color: Amber/Clear**

- General purpose
- High strength
- Resists shock at low temperature
- 25 second open time
- Softening point: 185°F
- Application temperature: 325°F to 380°F



**AVAILABLE SIZES:**

1/2" x 10" or 15" • 5/8" x 10" or 15" • 3/4" x 10" or 15" • 1" x 10" or 15"

### Chem-Set™ 725 Hot Melt

**SKU: FPC-725**

**Color: Clear**

- General purpose clear hot melt
- Designed to use low to high temperature glue gun
- Softening point: 176°F
- Open time: 65 seconds
- Application temperature: 250°F to 380°F



**AVAILABLE SIZES:**

1/2" x 10" or 15" • 5/8" x 10" or 15" • 3/4" x 10" or 15" • 1" x 10" or 15"

### Chem-Set™ QUAD 701 Hot Melt

**SKU: FPC-QUAD-701**

**Color: Amber Quadrack Hot Melt**

- All temperature perfect for packaging and carton sealing
- 15 second open time
- Softening Point: 178°F
- Application temperature: 250°F to 380°F

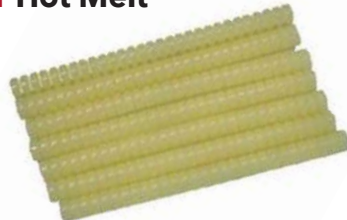

**AVAILABLE SIZE:**

5/8" x 8"

### Chem-Set™ QUAD 725 Hot Melt

**SKU: FPC-QUAD-725**

**Color: Clear Quadrack Hot Melt**

- All temperature perfect for packaging and carton sealing
- 60 second open time
- Softening Point: 178°F
- Application temperature: 178°F

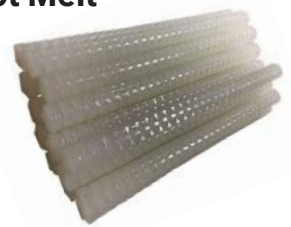

**AVAILABLE SIZE:**

5/8" x 8"

## Hot Melt Dispense Guns



### PRO2-450 Adjustable Temperature Glue Gun

**400 WATTS**



- Temperature adjustment from 220 °F to 400°F
- This gun uses standard (1/2", 7/16", 0.43") diameter glue sticks.
- Ergonomic finger trigger design for less effort
- Integrated gun balancer mount hole

**SKU: FPC-PRO450**



Includes: extra nozzles, detachable wire stand and storage case. Uses standard (1/2", 7/16", 0.43") diameter glue sticks. Interchangeable nozzles available.

### PRO2-220HT High Temperature Glue Gun

**220 WATTS**



- Ergonomic finger trigger design for less effort
- Operating Temperature 380° F
- Stroke adjustment screw
- Integrated gun balancer mount hole
- Protective heat resistant nozzle cover
- Lighted On/Off switch

**SKU: FPC-PRO2-220HT**



Includes: extra nozzle, detachable wire stand and storage case. Uses standard 7/16" (.43") diameter glue sticks. Weight: 1.6 lbs. Interchangeable nozzles available.

### HYBRID 120 Cordless Gun



- Can be used as a cordless glue gun or with the option to use an AC power cord with your glue gun
- 18V Ryobi sold separately which provides versatility and freedom of motion when needed.
- Battery lasts up to 1 hour
- Comes with heavy duty carrying case

**SKU: FPC-HYB120-KIT**

**100 WATTS**

### PRO2-100 High Temperature Glue Gun



- Ergonomic comfort grip and long trigger
- Operating Temperature 380°F
- Protective heat resistant nozzle cover
- Detachable wire stand
- Interchangeable nozzle
- On/Off switch

**SKU: FPC-PRO2-100**

Uses standard 7/16" (.43") diameter glue sticks. Weight .90 lbs. Interchangeable nozzles available.

See our complete line of hot melt adhesives @ [chemical-concepts.com](http://chemical-concepts.com)

# Dispense Guns Industrial

**Chem-Set™** Stocking Distributor: Adhesive Dispense Guns from Cox, Newborn, Sulzer and Albion. Manual & Pneumatic.

**DISPENSE GUNS SEE EACH PAGE FOR RECOMMENDED GUN TO USE WITH ADHESIVE**

## 250ml Dispenser

- Compatible with Mixpac 250ml cartridges systems
- 18:1 mechanical advantage reduces fatigue
- Sturdy steel frame doesn't flex or bend



**Integra Adhesives™**



## 500ml Dispenser

- Compatible with many other 400ml/470ml cartridges
- 25:1 mechanical advantage reduces fatigue
- Steel push rods braced with reinforced plate to prevent off-ratio mixing



250 ml

### VR210XSP

- 10:1 ratio for 210ml and 250ml cartridges
- 26:1 Thrust Ratio
- Sturdy steel frame doesn't flex or bend

SKU: NEW-VR210XSP



400 ml

### B26T400X10

- Albion B26T400X10 Hand Held
- 2-Part Manual Applicator
- 10:1 for 500ml cartridges

SKU: ALB-B26T400X10



200 ml

### DM2X 200

- Safe and clean working
- No cross-mixing
- Suitable for high-viscosity compounds

SKU: CON-DM2X200-01-52-01



400 ml

### DM2X 400

- Exceptional dispensing with full flexibility
- Unique dual drive mechanism
- Modern and Functional Design

SKU: CON-DM2X400-52-01



300 ml  
375 ml  
450 ml  
600 ml

### 535XSP

- 26:1 thrust ratio
- Easy Release Gripping Plate
- Hammered Finished Alloy Handle with Comfort Grip

SKU: NEW-535XSP-GUN



200 ml  
400 ml

### DP2X 200/400 Pneumatic

- Extraordinary precision
- Drip-free dispensing
- Fatigue free handling

SKU: CON-DP2X



310 ml

### H245

- Life-prolonging adjustment screw
- U-opening with cartridge snap-fit
- Fast, reliable, and easy to handle

SKU: CON-DM1K310-CA-R26-001



300 ml

### E12 12 Volt

- 10oz Cordless Cartridge Gun
- Variable Speed Trigger
- 400 lbs force dispensing power

SKU: ALB-E12



50 ml

### DS51

- 10:1 Mix Ratio for 50ml Seaming Adhesive
- Sturdy, high-quality, compact
- Convenient, cost-effective method to apply product with minimal waste

SKU: CON-DS51-10-00



50 ml

### CCH50G

- 50ml double barrel cartridges
- Easy converts from 1:1, 2:1, 4:1 and 10:1
- Impact Resistant Hardened Plastic body
- No-Drip design

SKU: CCH50G-1-1/2-1



250 ml

### NEW 250

- 18:1 thrust ratio
- For use with one part adhesives/sealants in 1/10 gal cartridges
- Revolving barrel

SKU: NEW-250



200 ml

### NEW-3-203

- 26:1 Thrust Ratio
- Precision Sintered Friction Plate
- Extra Durable, Heat Treated Piston Rod
- No Assembly required

SKU: NEW-3-203-XSP

See our complete line of industrial dispense guns @ [chemical-concepts.com](http://chemical-concepts.com)

# Abrasives and Pads

## Maroon Buff N Blend Non Woven Grip Back Discs - 320 A/O Grit

SIZE	PART NUMBER	DESCRIPTION	BOX QTY.
5"	05NWD707V	5" MAROON BUFF N BLEND GRIP DISCS	25
6"	06NWD707V	6" MAROON BUFF N BLEND GRIP DISCS	25
11"	11NWD707V	11" MAROON BUFF N BLEND GRIP DISCS	5



## Gray Buff N Blend Non Woven Grip Back Discs - 800 S/C Grit

SIZE	PART NUMBER	DESCRIPTION	BOX QTY.
5"	05NWD635V	5" GRAY BUFF N BLEND GRIP DISCS	25
6"	06NWD635V	6" GRAY BUFF N BLEND GRIP DISCS	25
11"	11NWD635V	11" GRAY BUFF N BLEND GRIP DISCS	5

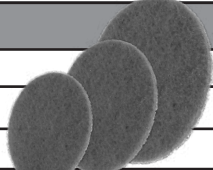



## Gold Buff N Blend Non Woven Grip Back Discs - 1200 A/O Grit



SIZE	PART NUMBER	DESCRIPTION	BOX QTY.
5"	05NWD636V	5" GOLD BUFF N BLEND GRIP DISCS	25
6"	06NWD636V	6" GOLD BUFF N BLEND GRIP DISCS	25
11"	11NWD636V	11" GOLD BUFF N BLEND GRIP DISCS	5



## Accessories

siaFast™ HOOK N' LOOP BACKUP PADS: 1 5/16" -24 THREAD		SIZE	GRADE	ARTICLE #.
	6" NO HOLE	3/8" THICK-FIRM LOW PROFILE	7486.5440.0000	
	6" 54 HOLE	3/8" THICK-SOFT, LOW PROFILE 3/8" THICK-HARD, LOW PROFILE	0020.6734 0020.6735	
	5" NO HOLE	1/2" THICK-SOFT EDGE 1/2" THICK-MEDIUM EDGE	0020.2039 4580.8409.0000	
	5" 54 HOLE	3/8" THICK-SOFT, LOW PROFILE 3/8" THICK-HARD, LOW PROFILE	0020.6728 0020.6729	
INTERFACE PADS		SIZE	GRADE	ARTICLE #.
	6" NO HOLE	3/8" THICK-FIRM LOW PROFILE	7486.5440.0000	
	6" 54 HOLE	3/8" THICK-SOFT, LOW PROFILE 3/8" THICK-HARD, LOW PROFILE	0020.6734 0020.6735	
	5" NO HOLE	1/2" THICK-SOFT EDGE 1/2" THICK-MEDIUM EDGE	0020.2039 4580.8409.0000	
	5" 54 HOLE	3/8" THICK-SOFT, LOW PROFILE 3/8" THICK-HARD, LOW PROFILE	0020.6728 0020.6729	

## 1950 siaspeed™ - at full speed to a perfect surface

1950 siaSpeed™ FiboTec™ siaFast™ Hook N' Loop Discs		SIZE	GRADE	ARTICLE #.	GRADE	ARTICLE #.	
	6" FiboTec™ 59 hole	120	2279.5390.0120	5" FiboTec™ 41 hole	120	4800.6167.0120	
		180	2279.5390.0180		180	4800.6167.0180	
		280	2279.5390.0280		280	4800.6167.0280	
		400	2279.5390.0400		400	4800.6167.0400	
		600	2279.5390.0600		600	4800.6167.0600	
		GRADE	ARTICLE #.			GRADE	ARTICLE #.
	6" no hole	120	7332.9183.0120	5" no hole	120	6783.7705.0120	
		180	7332.9183.0180		180	6783.7705.0180	
		280	7332.9183.0280		280	6783.7705.0280	
		400	7332.9183.0400		400	6783.7705.0400	
		600	7332.9183.0600		600	6783.7705.0600	
		1000*	7332.9183.1000		1000*	6783.7705.1000	



# Abrasives and Pads

## Blue Film Grip Disc

SIZE		H&L	PSA	GRIT RANGE	BOX QTY
3 1/2" X 7 HOLE FESTOOL		X	X	80-1000	100
3 1/2" X NO HOLE		X	X	80-2000	100
5" X NO HOLE		X	X	80-2000	100
5" X 5 HOLE		X	X	80-1000	100
5" X 8 HOLE BOSCH		X	X	40-220	100
5" X 9 HOLE FESTOOL		X	X	40-220	100
6" X NO HOLE		X	X	80-2000	100
6" X 6 HOLE BOSCH, RIGID, PORTER CABLE		X	X	40-220	100
6" X 8 HOLE FEIN		X	X	40-220	100
6" X 9 HOLE FESTOOL		X	X	40-220	100
6" X 15 HOLE UNIVERSAL HOLE PATTERN		X	X	40-220	100
8" X NO HOLE		X	X	80-2000	25
11" X NO HOLE		X	X	80-2000	25
11" X 5" DONUT HOLE		X	X	80-2000	25



### Chem-Set™ 11" Orbital Gem Sander (Hook & Loop)

- Heavy-duty ball bearing capacitor motor
- No gears to grind or strip out
- No carbon brushes to burn out
- No armature winding to burn out
- Exclusive removable shaft system
- Sands, polishes and finishes. Best deal anywhere
- Available with HOOKIT or HOOKIT II pad



**FEATURES**

**Features**

- Heavy-duty ball bearing capacitor motor
- No gears to grind or strip out
- No armature winding to burn out
- No carbon brushes to burn out
- Exclusive removal shaft system
- Sands, polishes and finishes

**SPECIFICATIONS**

**Specifications**

Weight..... 18 lbs.

Overall height..... 10in.

Amps ..... 2.3@110v, 1.2@220v

RPM..... 1,77@11v

Moto ..... 110v/220v

Housing..... heavy-duty aluminum

**SKU: CCH-BW-HL**

See our complete line of Chem-set™ Abrasives and Pads @ [Chemical-concepts.com](http://Chemical-concepts.com)

# Laminate and Woodworking Adhesives



## Tensorgrip® P300

### High Temp General Purpose Contact Adhesive

Designed to deliver a smooth and strong bond in nearly any application.

- Fast, high tack
- Excellent green strength and high heat resistance (over 220°F/105°C)
- Fast drying with long open time
- Excellent high coverage

SKU: Q-P300



## Tensorgrip® P302

### Non-Flam High Temp Contact Adhesive

Designed to be a versatile, safe and reliable adhesive.

- Excellent high coverage
- 80% of final strength immediately
- Full strength in 24 hours
- Fast drying with long open time
- Good heat resistance (up to 220°F/105°C)

SKU: Q-P302



## Tensorgrip® P307

### Low VOC Contact Adhesive

Aggressive and versatile, bonding flexible and porous materials with ease.

- Excellent bonding to porous substrates
- Good heat resistance (up to 180°F/82°C)
- High-strength, long-term bond
- Strong initial bond
- Low VOC California Compliant (SCAQMD Rule 1168)

SKU: Q-P307



## Tensorgrip® P321

### Polystyrene Foam Contact Adhesive

Designed as a portable, self-contained spray system for field or shop applications.

- Will not attack polystyrene
- Fast tack
- Water resistant
- No chlorinated solvents
- Permanent contact adhesive bond
- 80% of final strength achieved immediately
- Full strength achieved in 24 hours

SKU: Q-P321



## STA'-PUT® SP80

A high performance aerosol contact adhesive that can be used on a variety of substrates. It gives a water-resistant, non-staining bond for common HPL applications.

- Low VOC non chlorinated
- Quick Grab Tack
- High Strength bonds
- Use brush roller or spray
- Smooth, flat spray pattern
- High Green Strength
- OTC States Compliant
- Excellent adhesion to many substrates
- SCAQMD Compliant—Rule 1168

SKU: TACC-SP80



## STA'-PUT® S200

Specifically for bonding high pressure laminates to various substrates. Suitable for a variety of applications in woodworking, manufactured housing, general construction, recreational vehicle, marine, furniture, textile, HVAC upholstery and more.

- Aggressive Grab Tack
- Quick Dry Time
- Long Open Time
- High Green Strength
- Excellent adhesion to many substrates
- Flatwork Applications (non-postforming)
- Self-Contained Portable Spray System

SKU: TACC-S200-38C



## Chem-Set™ 315M

High solids contact bond adhesive in a non-flammable solvent. Formulated for use in bonding a wide variety of materials.

- Non-flammable
- Solvent based
- Spray grade
- Brush, roller, or spray
- Available in pails and drums
- Bonds plastic laminates, metals, foams, wood
- Low VOC/OTC compliant

SKU: AW315M-05C



## Chem-Set™ 205M

Non-flammable, solvent based, high performance contact adhesive suitable for bonding decorative laminate, wood, particleboard, metal, rubber, hardboard, plywood and many other materials.

- Neoprene runner based
- Post form grade
- Automotive vinyl
- Non-flammable
- Low VOC/OTC compliant
- Solvent based
- Long open time
- High temperature
- Brush, roller, or spray
- Available in pails and drums
- Bonds plastic laminates, metals, foams, and wood

SKU: AW205M

See our complete line of products @ [chemical-concepts.com](http://chemical-concepts.com)

# Laminate and Woodworking Adhesives

## Integra Adhesives

### UNIKA COLORFILL LAMINATE JOINT SEALANT

Unika ColorFill is specifically designed to repair laminate and melamine flooring simply and effectively. ColorFill is an easy to use self setting material which requires no mixing. ColorFill is applied using a spatula and is touch dry in one hour.

- It seals the joint against water and domestic detergents
- Exactly color matched to the worktop, making the finished joint almost invisible
- It keeps the worktop hygienically clean by creating a tight joint there is no place for dirt and germs to collect
- Easy to apply. Dries quickly
- Good heat resistance to 140°C
- UV resistant



### UNIKA COLORJOINT LAMINATE JOINT SEALANT

ColorJoint is a color matched adhesive and sealant for interior use. It is designed principally to be used on compact laminate surfaces, but can also be used on quartz, laminate, stainless steel, glass and more. It is an excellent gap or joint filler, has very little shrinkage, and is UV stable. It lasts longer in the joint and does not pick up dirt, like silicone.

- Durable, permanent elastic
- Universal bonding for interior use
- Fast curing. Wet in wet applicable
- Adheres perfectly without primer on most, even damp, surfaces
- Free of isocyanates, solvents and silicones
- No shrinkage and bubble free
- Good resistant to water
- Neutral curing, almost odorless



### UNIKA MITREBOND ADHESIVE & PEN

MitreBond is an instant bonding low viscosity adhesive to give greater bond strength on porous surfaces. MitreBond can be applied to a wide variety of materials including - MDF, Timber, Glass, Ceramics, Aluminium, Chipboard, Perspex, Steel, Porcelain and some plastics. Apply drops along one side of the joint and then apply MitrePen or MitreBond Aerosol Activator to the other side. Quickly bring the two sides into line and firmly press the joint together. Hold for 10 seconds and it's complete

#### MITREBOND BENEFITS

- MitreBond is quick and clean and sets in 10 seconds
- No mixing or heating
- Use one or two drops per joint - a 50g bottle is sufficient for 100 cornice joints
- Result is a very clean and tight joint every time
- Apply to: MDF, Timber, Glass, Ceramics, Aluminium, Chipboard, Perspex, Steel, Porcelain, Some Plastics
- Use on Cornice & Profile Mitre Joints, Melamine end strips, door trims, picture frames, MDF skirting joints etc

#### MITREPEN BENEFITS

- MitrePen is used to apply the MitreBond activator
- Set superglue in 10 seconds
- Quick and clean - a precision marker to prevent overspray staining
- No yellowing
- Covers the same area as 3x 200ml activator sprays
- Environmentally friendly



See our complete line of seaming adhesives @ [chemical-concepts.com](http://chemical-concepts.com)



# REVOLUTIONIZE YOUR FABRICATION PROCESS:

Cut better, faster, and cleaner with Xcelerate. **Xcelerate's S-Complex** helps your cutting speed while the Slurry Sep helps improve water quality. To get the best performance from the S-Complex, you need good-quality water.

- Faster cutting speeds
- Cleaner cuts
- Increased throughput in production
- 30% better diamond life
- Cleaner water hitting your machines



Cut 3-5X Faster and Extend Diamond Life by 30%



## Improve Water Quality

The companion to the S-Complex is the Slurry Sep CF, a highly effective flocculant and coagulant, designed to work in tandem with the cutting additive. To get the best performance from the S-Complex and from your machines, you need good-quality water.



**Before**  
Untreated  
Gray Water



**After**  
Add 3 pinches of  
Slurry Sep CF and  
shake for 30 seconds

# WE'RE HERE FOR YOU **TALK TO THE MANUFACTURING EXPERTS**

Interested in a product? Want to learn more about how we can help your manufacturing business?

**Get in touch with the experts.**

## SOUTHEAST



**Matt Avin**  
Territory Sales Representative  
678-790-4513

## GREAT LAKES



**Teri Obloy**  
Territory Sales Representative  
330-942-5273

## MID-ATLANTIC



**Rick Ferra**  
Territory Sales Representative  
856-770-4495

## SOUTH ATLANTIC



**John Burke**  
Territory Sales Representative  
267-885-3976



## NORTHEAST



**Michael Smith**  
Territory Sales Representative  
267-250-6912



**Andrew Morris**  
National Sales Manager  
267-218-3481



**CONTACT US**  
[chemical-concepts.com/contact-us/](http://chemical-concepts.com/contact-us/)



**Craig Zelle**  
Vice President, Sales  
215-264-7065

# SHOP ALL YOUR COUNTERTOP FABRICATION NEEDS AT

CHEMICAL-CONCEPTS.COM

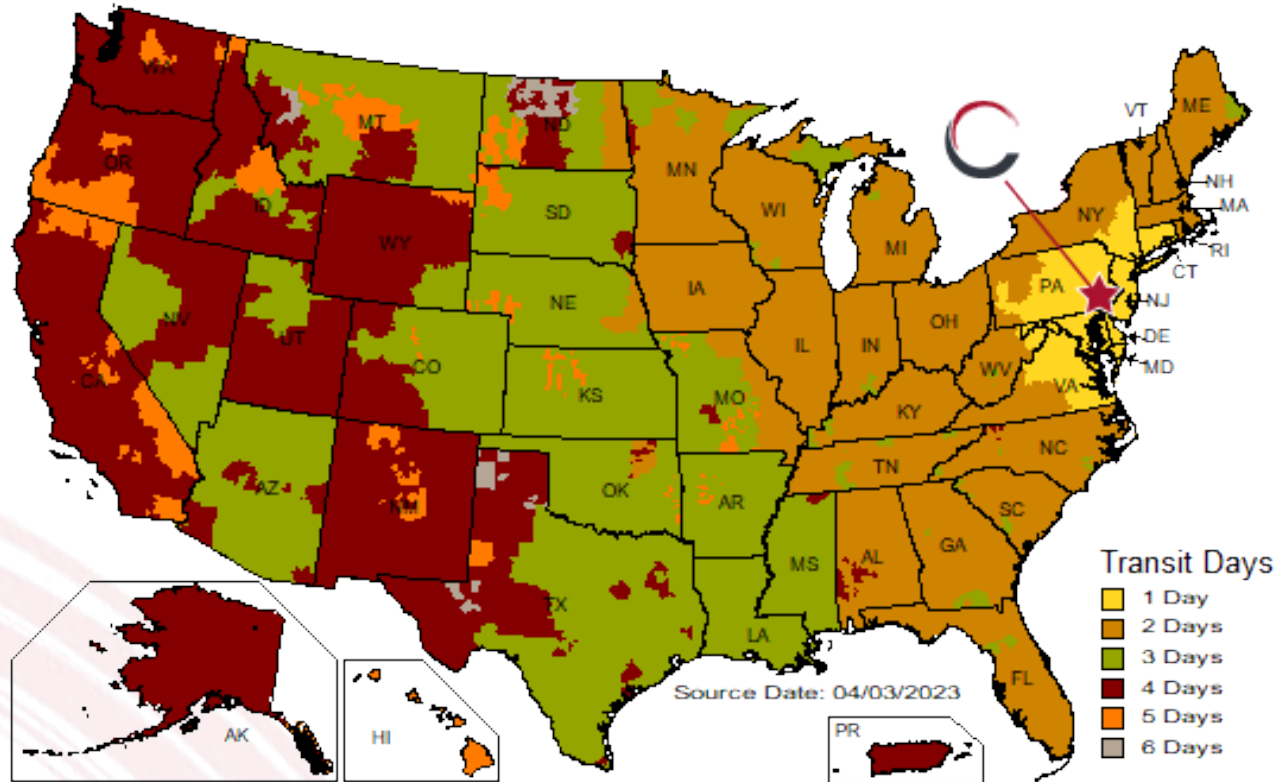

## How to Order?

Get in touch with us today.

 Toll Free:  
800.220.1966

 orders@chemical-concepts





